

Panasonic

Compact Plain Paper FAX

Model No.

KX-FP270

KX-FP265

Quick Start



To get started,
please read the
Quick Start section
(pages 4 to 13).

OPERATING INSTRUCTIONS

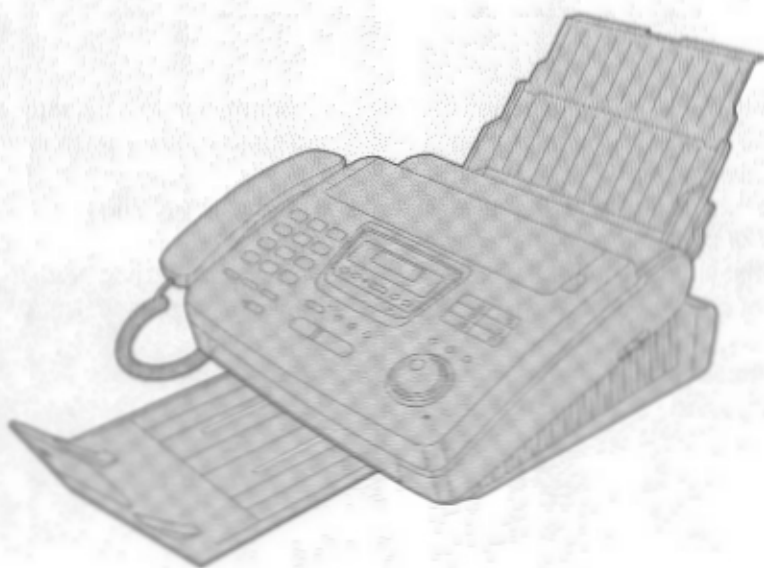

Please read these Operating Instructions before using the unit and save for future reference.

- This unit is designed for use in the United States of America, and may not operate in other countries. (See page 128 for more details.)
- Este producto ha sido diseñado para su uso en los Estados Unidos de América, y puede no funcionar correctamente en otros países. (Consulte la página 128 para tener más detalles.)

FOR OPERATION ASSISTANCE,
CALL 1-800-HELP-FAX (1-800-435-7329)
OR SEND A FAX TO 1-215-741-6376.

Comienzo Rápido (p. 129)

Initial
Preparation

Telephone

Fax/Copy

Answering
Device

Help

General
Information

Comienzo rápido
en español (p. 129)

Thank you for purchasing a Panasonic facsimile.

Welcome to the world of Panasonic facsimiles.

This product combines the facsimile, telephone, telephone answering device and copier features to provide you with more efficient office or home use. By utilizing these convenient features, you can maximize the effectiveness of this unit.

Things you should keep record of

Attach your sales receipt here

For your future reference

Date of purchase

Serial number

(found on the bottom of the unit)

Dealer's name and address

Dealer's telephone number

Caution:

- o The Telephone Protection Act of 1991 requires the following information to be clearly stated either at the top or bottom margin of the first message page when transmitting messages via telephone facsimile;
 - Date and time of transmission,
 - Identification of the business, entity or person(s) sending the facsimile, and
 - Telephone number of the business, entity or person(s).To program this information into your unit, complete all the instructions on pages 29 to 32.
- o Note that the images of copied or received documents will remain on the used film. When disposing of the used film, use discretion.
- o Do not rub or use an eraser on the printed side, as the print may smear.
- o If you have not applied to the *faxSÄV*® service, you will not be able to use the IQ-FAX function (see pages 57 to 59).

Trademarks

faxSÄV is a registered trademark of FaxSav Incorporated.

Hammermill® is a registered trademark of INTERNATIONAL PAPER in the United States and/or other countries.

Copyright:

This manual is copyrighted by Kyushu Matsushita Electric Co., Ltd. (KME) and its licensee. Under the copyright laws, this manual may not be reproduced in any form, in whole or part, without the prior written consent of KME and its licensee.

© Kyushu Matsushita Electric Co., Ltd. 1998

Important safety instructions

When using this unit, basic safety precautions should always be followed to reduce the risk of fire, electric shock, or personal injury.

1. Read and understand all instructions.
2. Follow all warnings and instructions marked on this unit.
3. Unplug this unit from AC outlets before cleaning. Do not use liquid or aerosol cleaners. Use a damp cloth for cleaning.
4. Do not use this unit near water, for example near a bath tub, wash bowl, kitchen sink, or the like.
5. Place the unit securely on a stable surface. Serious damage and/or injury may result if the unit falls.
6. Do not cover slots and openings on the unit. They are provided for ventilation and protection against overheating. Never place the unit near radiators, or in a place where proper ventilation is not provided.
7. Use only the power source marked on the unit. If you are not sure of the type of power supplied to your home, consult your dealer or local power company.
8. For safety purposes this unit is equipped with a three prong grounded plug. If you do not have this type of outlet, please have one installed. Do not use any type of adaptor plug to defeat this safety feature.
9. Do not place objects on the power cord. Install the unit where no one can step or trip on the cord.
10. Do not overload wall outlets and extension cords. This can result in the risk of fire or electric shock.
11. Never push any objects through slots in this unit. This may result in the risk of fire or electric shock. Never spill any liquid on the unit.
12. To reduce the risk of electric shock, do not disassemble this unit. Take the unit to an authorized servicer when service is required. Opening or removing covers may expose you to dangerous voltages or other risks. Incorrect reassembly can cause electric shock when the unit is subsequently used.
13. Unplug this unit from the wall outlet and refer servicing to an authorized servicer when the following conditions occur:
 - A. When the power supply cord or plug is damaged or frayed.
 - B. If liquid has been spilled into the unit.

- C. If the unit has been exposed to rain or water.
 - D. If the unit does not work normally by following the operating instructions. Adjust only controls covered by the operating instructions. Improper adjustment may require extensive work by an authorized servicer.
 - E. If the unit has been dropped or physically damaged.
 - F. If the unit exhibits a distinct change in performance.
14. During thunderstorms, avoid using telephones except cordless types. There may be a remote risk of an electric shock from lightning.
 15. Do not use this unit to report a gas leak, when in the vicinity of the leak.

SAVE THESE INSTRUCTIONS

INSTALLATION:

1. Never install telephone wiring during a lightning storm.
2. Never install telephone jacks in wet locations unless the jack is specifically designed for wet locations.
3. Never touch uninsulated telephone wires or terminals unless the telephone line has been disconnected at the network interface.
4. Use caution when installing or modifying telephone lines.

WARNING:

- o To prevent the risk of fire or electrical shock, do not expose this product to rain or any type of moisture.

OTHER INFORMATION

- o Keep the unit away from electrical noise generating devices, such as fluorescent lamps and motors.
- o The unit should be kept free from dust, high temperature and vibration.
- o The unit should not be exposed to direct sunlight.
- o Do not place heavy objects on top of this unit.
- o Do not touch the plug with wet hands.

Quick Start

Installation

Remove the shipping tape from the unit and paper stacker, and install as follows.

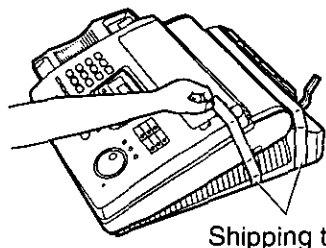

Shipping tape

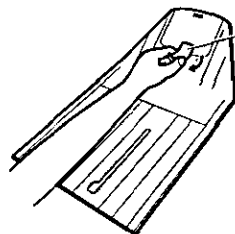

Shipping tape

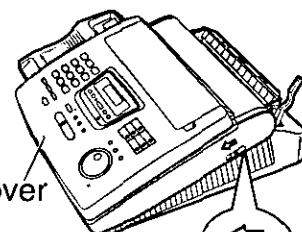

Cover

1

Film cartridge (See pages 23 and 24.)

- A. Slide the cover open lever forward.
- B. The cover is under tension to improve print quality. Pull up hard enough to open.
- C. Remove the leaflet from the unit.
- D. If the film in the film cartridge is slack, tighten it by winding the bottom side gears.

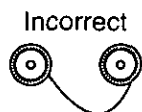

Incorrect

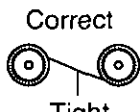

Correct

Tight

- E. Install the film cartridge into the unit.
- F. Make sure that the blue label on the cartridge matches the one on the unit.
- G. Close the cover securely by pushing down on both ends.

Cover open lever

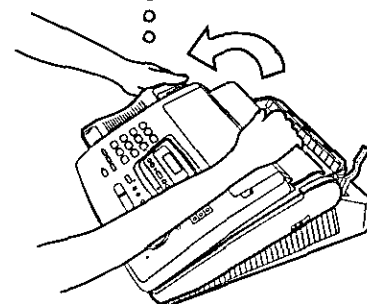

Blue label

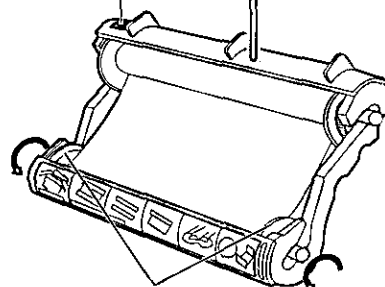

Bottom side gears

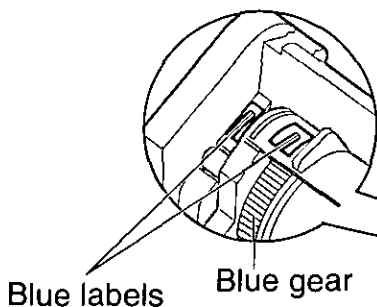

Blue labels

Blue gear

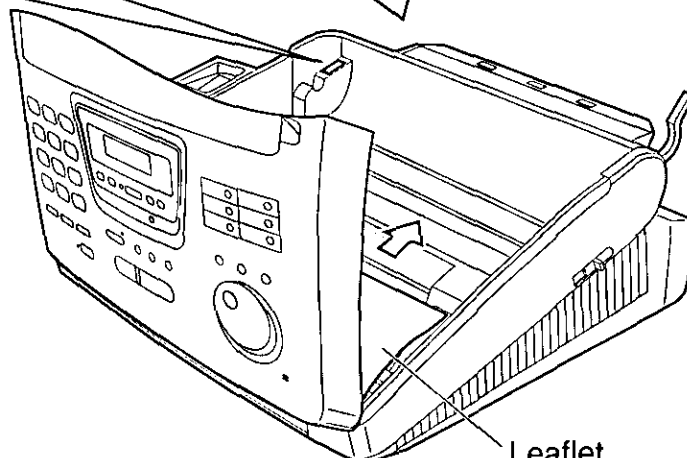

Leaflet

2

Paper stacker (See page 25.)

- A. Lift the front of the unit, insert the paper stacker into the slots and slide it until it stops.

3

Paper tray (See page 26.)

- A. Open the paper tray.
B. Insert the two tabs on the paper tray into the slots on the back of the unit.

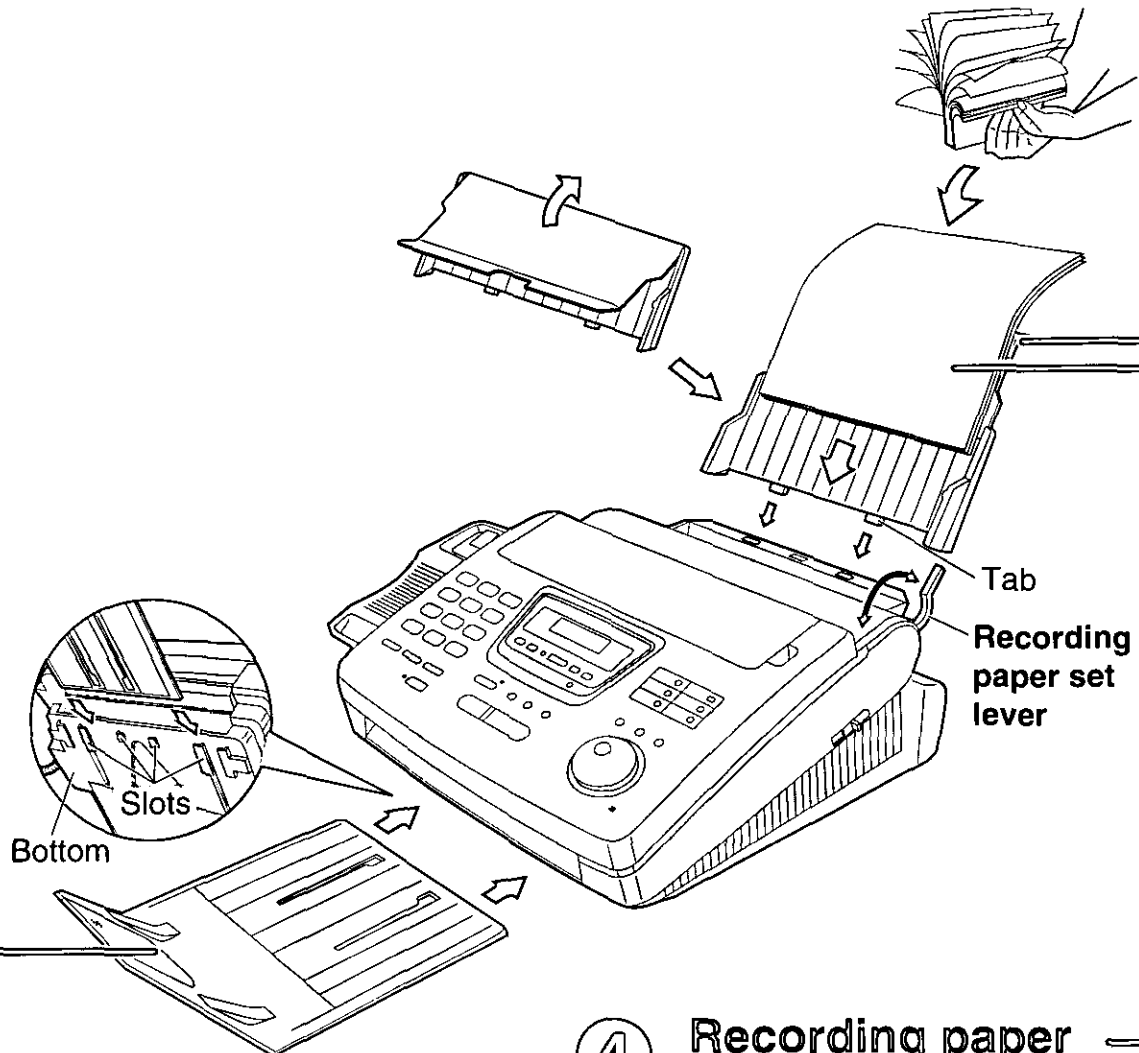

4

Recording paper (See pages 26 and 27.)

(See pages 26 and 27.)

- A. Pull the recording paper set lever forward.
B. Fan the stack of paper to prevent a paper jam and insert the paper into the paper tray.
C. Move the recording paper set lever back.

Quick Start

Connections

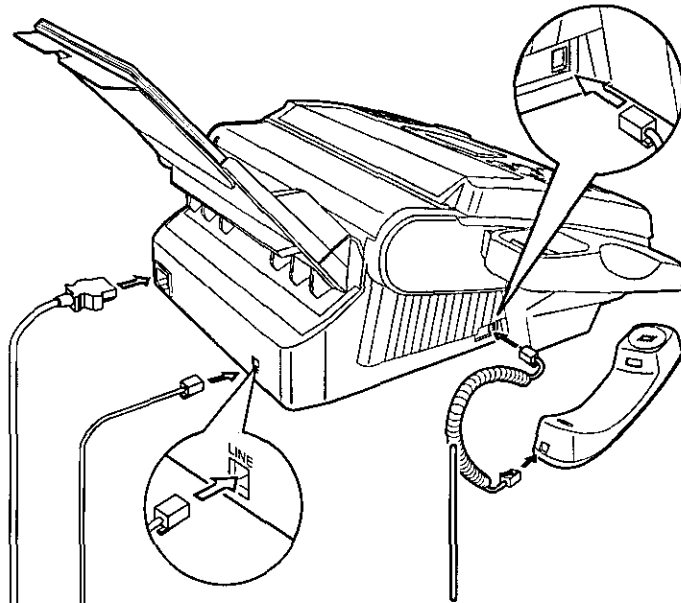

①

Handset cord

- A. Connect to the unit.
- B. Connect to the handset.

②

Telephone line cord

- A. Connect to "LINE" on the unit.
- B. Connect to a single telephone line jack.

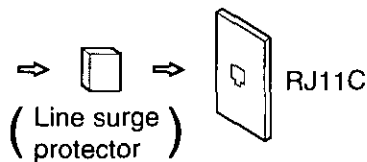

③

Power cord

- A. Connect to the unit.
- B. Connect to a power outlet.

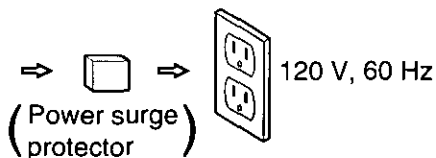

o For further details, see page 28.

Voice calls - making/answering

Voice calls - making

① Lift the handset.

② Dial the number.

③ When finished,
hang up the handset.

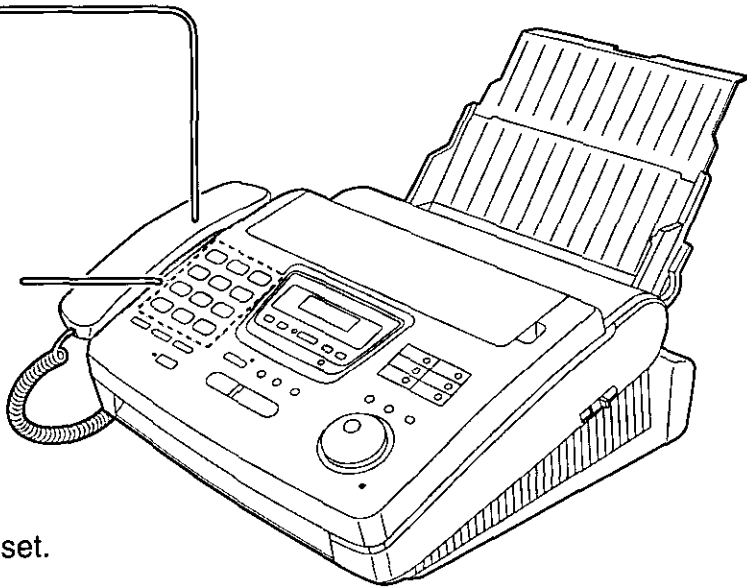

- For further details, see page 34.
- If you have problems making a call, see page 111.

Quick Start

Voice calls - answering

- 1 When the unit rings, lift the handset.

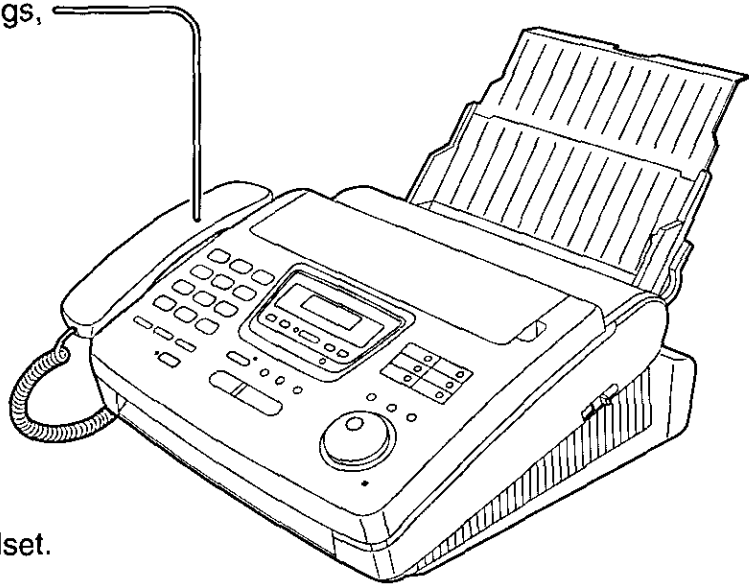

- 2 When finished, hang up the handset.

- o For further details, see page 35.
- o If you have problems answering a call, see page 111.

Fax - sending/receiving

Fax - sending

- ① Open the document feeder tray.

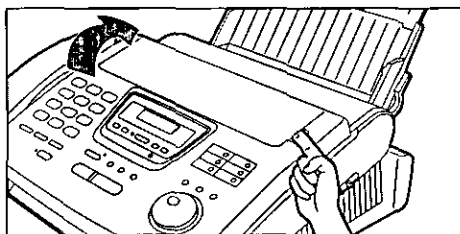

- ② Adjust the width of the document guides to the size of the document.

- ③ Insert the document until a single beep is heard and the unit grabs the document.

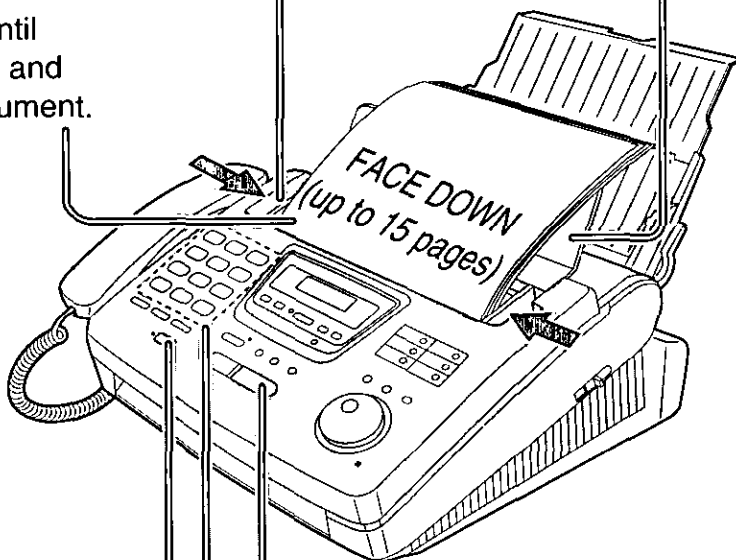

- ④ Press **DIGITAL SP-PHONE**.

- ⑤ Dial the fax number.

- ⑥ When a fax tone is heard, press **START/COPY/SET**.

⦿ For further details, see page 54.

⦿ If you have problems sending a fax, see pages 111 and 112.

Quick Start

Fax - receiving

- ① When the unit rings, lift the handset.

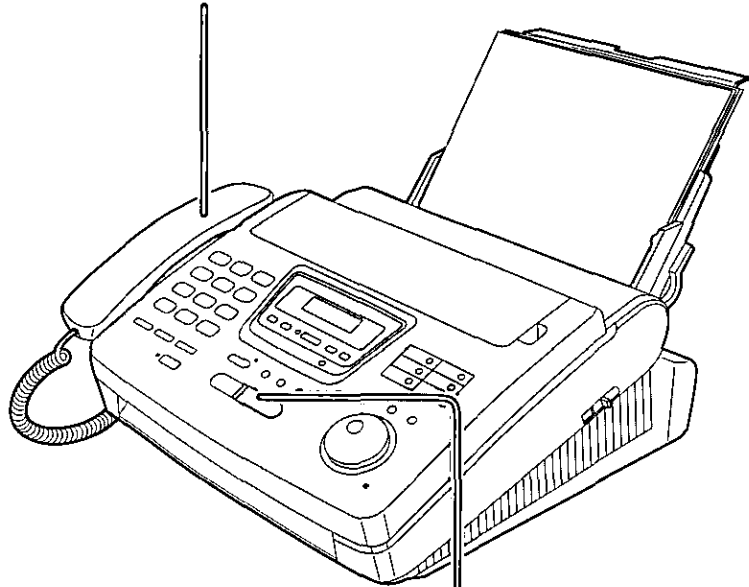

- ② When:
 - document reception is required,
 - a fax calling tone (slow beep) is heard, or
 - no sound is heard,press **START/COPY/SET**.

- ③ Hang up the handset.

- o For further details, see page 72.
- o **You can select which way to receive calls according to your needs. See pages 70 and 71.**
- o If you have problems receiving a fax, see page 112.

Copy - making

- ① Open the document feeder tray.

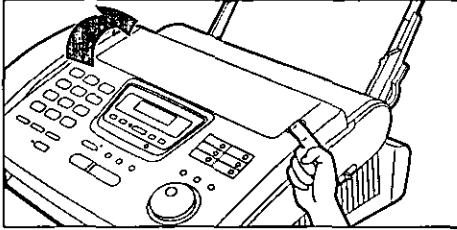

- ② Adjust the width of the document guides to the size of the document.

- ③ Insert the document until a single beep is heard and the unit grabs the document.
• Make sure the handset is on the unit.

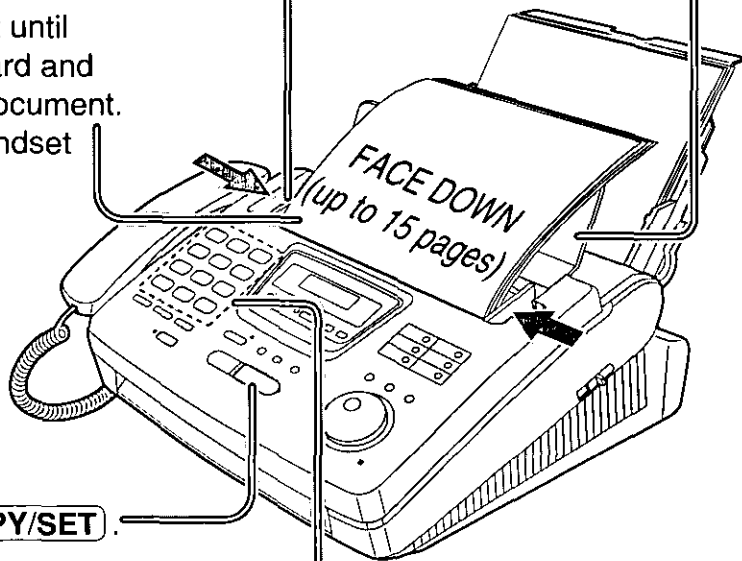

- ④ Press **START/COPY/SET**.

- ⑤ Enter the number of copies (up to 99).

- ⑥ Press **START/COPY/SET**.

- For further details, see page 87.
- If you have problems making a copy, see page 113.

Quick Start

Operating the answering device

Setting the unit to receive voice messages and fax messages automatically

- 1 Press **AUTO ANSWER** until the AUTO ANSWER light turns on.

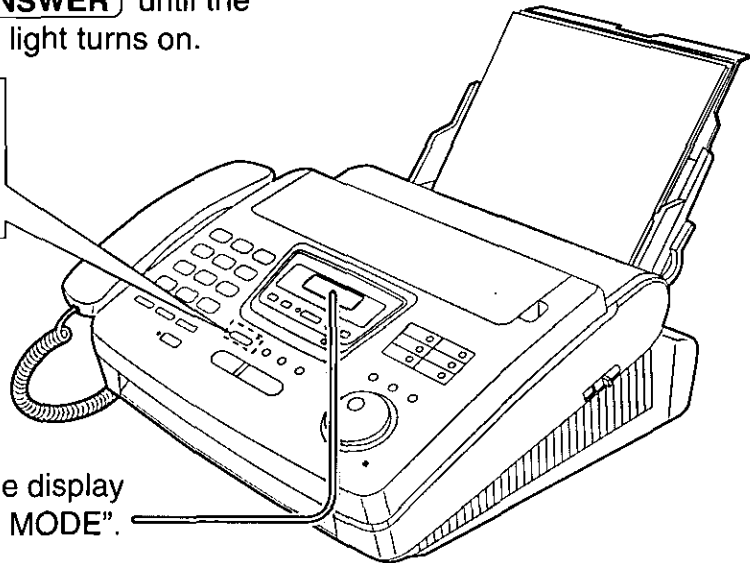
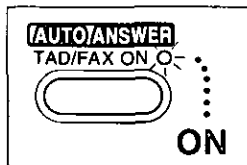

- 2 Make sure that the display shows "TAD/FAX MODE".

- o If the display does not show "TAD/FAX MODE" when the AUTO ANSWER light turns on, the setting needs to be changed to the TAD/FAX mode. See page 73.
- o For further details, see page 89.

Listening to recorded messages

- 1 Press **PLAY MESSAGES** when the **PLAY MESSAGES** light is flashing or on.
 - When the **PLAY MESSAGES** light is:
 - flashing, the unit will only play the new messages.
 - on, the unit will play all the messages.

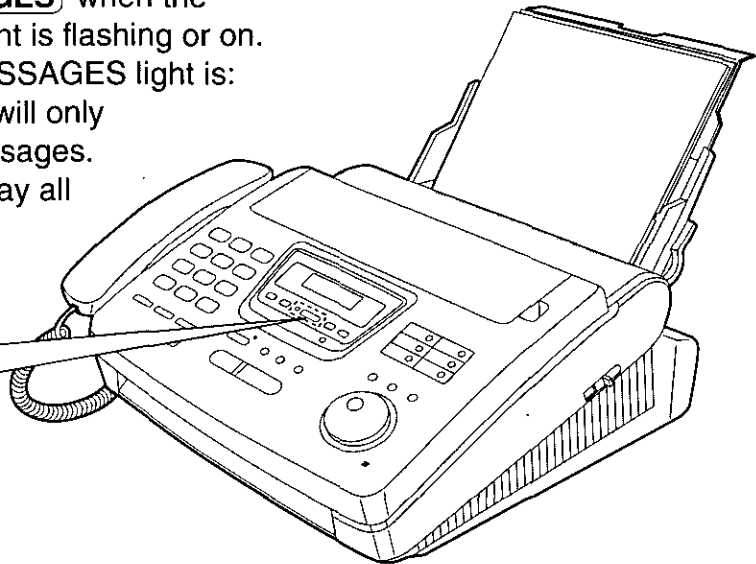
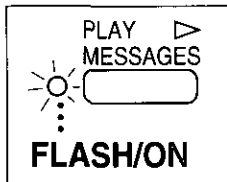

• For further details, see page 94.

Erasing recorded messages

Erasing a specific message

- 1 Press **ERASE** while listening to the message you want to erase.

Erasing all the messages

- 1 Press **ERASE** after listening to all of the messages.
- 2 Press **START/COPY/SET**.
- 3 Press **START/COPY/SET** again.

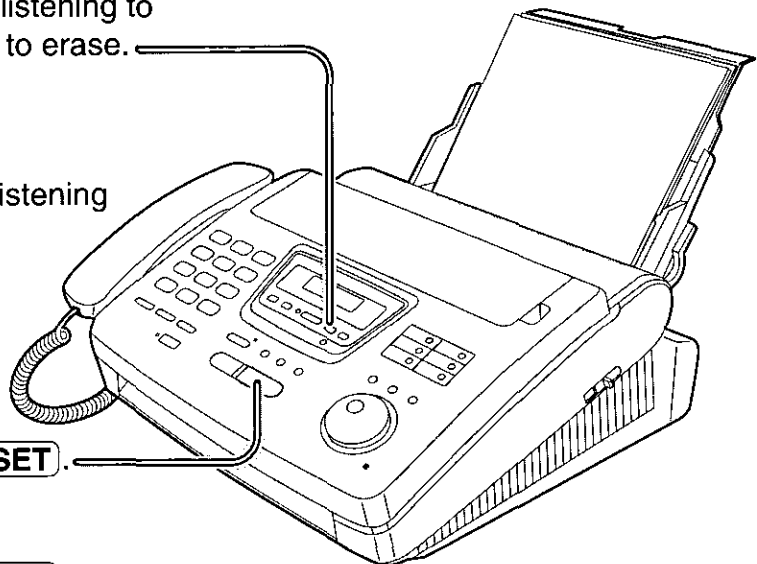

• For further details, see page 94.

Table of Contents

Initial Preparation	Accessories	Included accessories	17
		Accessory order information	18
	Help Button	Help function	19
	Finding the Controls	Location	20
		Overview	22
	Setup	Film cartridge	23
Paper stacker		25	
Paper tray		26	
Recording paper		26	
Connections		28	
Date and time, your name and facsimile telephone number		29	
Volumes	Adjusting volumes	33	
Telephone	Making and Answering Calls	Voice calls - making	34
		Voice calls - answering	35
		TONE, FLASH and PAUSE buttons	36
		Dialing mode (touch tone or pulse)	37
	One-Touch Dial	Storing names and telephone numbers in the One-Touch Dial	38
		Making a voice call using the One-Touch Dial	40
	JOG DIAL	Storing names and telephone numbers in the JOG DIAL directory	41
		Making a voice call using the JOG DIAL directory	44
	Caller ID	Caller ID service from the phone company	45
		Viewing the Caller ID list on the display	46
		Calling back from the Caller ID list	47
		Storing a telephone number in the One-Touch Dial and JOG DIAL directory from the Caller ID list	48
		Erasing a name/number from the Caller ID list	49
		Storing your area code	51
		Automatic Caller ID list	52
Voice Contact	Talking to the caller after fax transmission or reception	53	
Fax/Copy	Sending Faxes	Sending a fax manually	54
		Sending a fax using the One-Touch Dial	55
		Sending a fax using the JOG DIAL directory	56
		IQ-FAX	57
		Documents you can send	60
		Sending faxes by following the voice guide	61
		Sending report for confirmation	62
		Automatic journal report	63
		Delayed transmission (sending a fax at a specified time)	64
		From memory	65
		Multiple stations	66
		Overseas	68
		Connecting tone	69



Fax/Copy	Receiving Faxes Setting the unit to receive calls 70 TEL mode (answering all calls manually) 72 FAX ONLY mode (all calls are received as faxes) 73 Setting up with a computer 75 Distinctive Ring service (ring pattern detection feature) .. 76 TEL/FAX mode (receiving voice calls with rings and fax calls without rings when you are near the unit) ... 78 Extension telephone 82 Fax activation code 82 Other size documents 83 Memory reception alert 84 Friendly reception 84 Pager call - when your unit receives a fax 85 Film detection 86 <hr/> Copying Making a copy 87	Initial Preparation Telephone
Answering Device	Setup TAD/FAX mode (using the built-in answering device and receiving voice and fax calls automatically) 89 <hr/> Greeting Pre-recorded greeting messages 90 Recording your own greeting messages 91 Erasing your own recorded greeting messages 92 Recording time for the TAD/FAX greeting message 93 <hr/> Playing Messages Listening to recorded messages 94 Erasing recorded messages 94 Functions while playing a message (repeating, skipping and stopping) 95 <hr/> Recording Memo message (leaving a message for others or yourself) .. 96 Telephone conversation 96 <hr/> Remote Operation Operating from a remote location 97 Setting the remote operation ID 98 From a remote touch tone telephone 99 <hr/> Options Transferring recorded messages to another phone 102 Ring count in the TAD/FAX mode 105 Incoming message recording time 106 Message alert (beeps when a voice message is received) .. 106 Recording time alert (beeps when memory is almost full) .. 107 Setting the ICM monitor 107	Fax/Copy Answering Device Help
Help	Error Messages Reports 108 LCD display 109 <hr/> Operations When a function does not work, check here before requesting help 111 If a power failure occurs 114 <hr/> Jams Recording paper jam 115 Sending document jams 117 Sending document does not feed, or multi-feeds 117 <hr/> Ink Film How much film you have left 118 Replacing the film or film cartridge 118 <hr/> Cleaning Document feeder 120 Thermal head and black bar 120	General Information Comienzo rápido en español (p. 129)

General Information	Reports	Printing the feature settings, telephone numbers, the journal, printer test list and Caller ID list	121
	Fax Voice Guidance	Fax voice guidance	122
	Display Contrast	Changing the LCD display contrast	123
	Reset	Resetting the advanced features	123
	FCC Information	List of FCC requirements and information	124
	Warranty	Limited Warranty	125
		Servicenter Directory	126
		Notes for product service and shipping the product	127
Specifications	Technical data about this product	128	
Comienzo rápido en español	Comienzo rápido en español	129	
<hr/>			
	Index	138	
	Features Summary Summary of user programmable features	140	

Included accessories

To order, call toll free 1-800-435-7329 or see the fax order instructions on page 18.

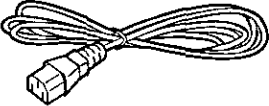
Initial
Preparation

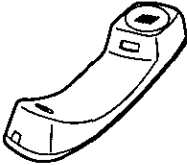
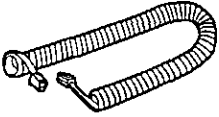
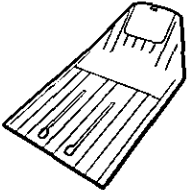
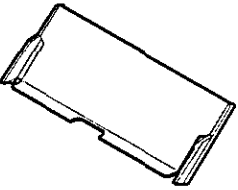
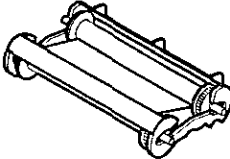
<p>Power cord..... 1 pc. Part No. PQJA200Z</p> 	<p>Telephone line cord 1 pc. Part No. PQJA59V</p> 	<p>Handset 1 pc. Part No. PFJXE0105Z</p> 	<p>Handset cord..... 1 pc. Part No. PQJA212M</p> 
<p>Paper stacker 1 pc. Part No. PFZE1FP250M</p> 	<p>Paper tray 1 pc. Part No. PFYEFP200M</p> 	<p>Film cartridge..... 1 pc. (with free starter film)</p> 	

- If any items are missing or damaged, check with the place of purchase.
- The part numbers listed above are subject to change without notice.
- Save the original carton and packing materials for future shipping and transporting of the unit.

Accessories

Accessory order information

The free starter film is only 20 meters (65') long. We recommend that you buy regular film [100 m (328')] for uninterrupted use of your unit.

For best results, use Panasonic replacement film, KX-FA135 or KX-FA136.

To order, call toll free 1-800-435-7329 or see the fax order instructions below.

Fax order: Please send a fax to 1-800-237-9080. Include: Your name, shipping address, telephone number, credit card type, number, expiration and your signature, order part number and quantity, delivery method – overnight, 2nd day, or ground.

Model No.	Description	Specifications
KX-FA135	Film cartridge	1 cartridge and 1 film [216 mm x 100 m (8½" x 328') roll] (The film has already been installed in the cartridge.)
KX-FA136	Replacement film	2 films [216 mm x 100 m (8½" x 328') rolls] (Film only. Use with your original cartridge.)

Note:

- **The film is not reusable. Do not rewind and use the film again.**
- The films above can be used with your unit even though your unit's model number (KX-FP270/KX-FP265) is not listed on the film's box.

Help function

You can print a quick reference for assistance as follows.

1 Press **HELP**.

Display: **PRESS [▼▲] & [SET]**

2 Press **▼** or **▲** until the desired item is displayed. The following items are available.

1. How to program your unit

1. HOW TO SET UP

2. How to store names in the JOG DIAL directory and how to dial them

2. JOG/AUTO DIAL

3. Help with problems operating answering device

3. TAD OPERATION

4. Help with problems sending faxes

4. FAX SENDING

5. Help with problems receiving faxes

5. FAX RECEIVING

6. How to use the copier function

6. COPIER

7. Frequently asked questions and answers

7. Q and A

8. Explanation of error messages shown on the display

8. ERRORS

9. List of available reports

9. REPORTS

10. How to use the Caller ID service

10. CALLER ID

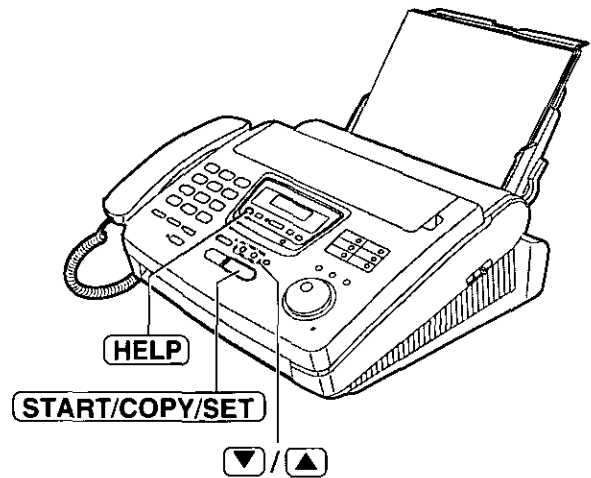

3 Press **START/COPY/SET**.

PRINTING

Finding the Controls

Location

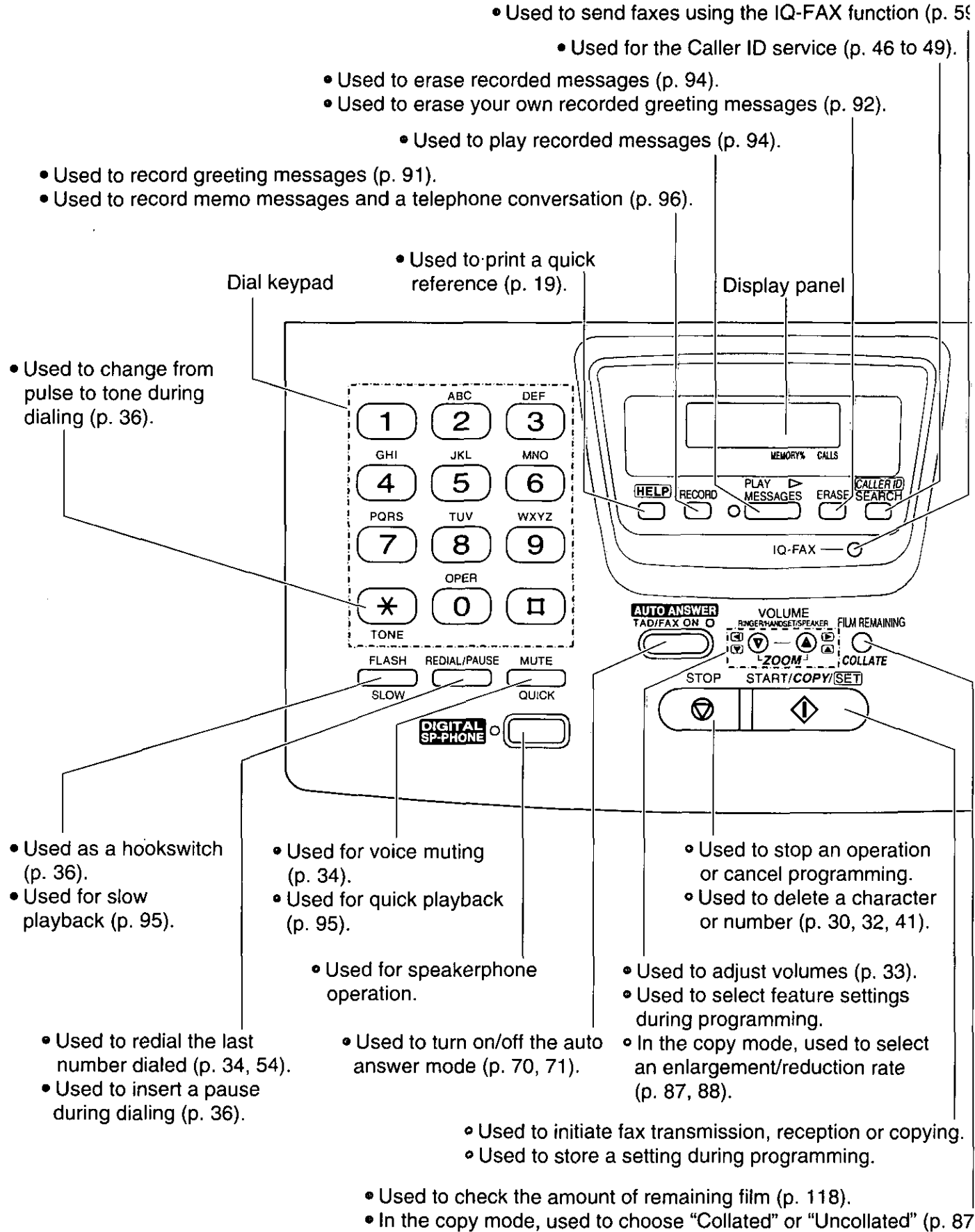

Finding the Controls

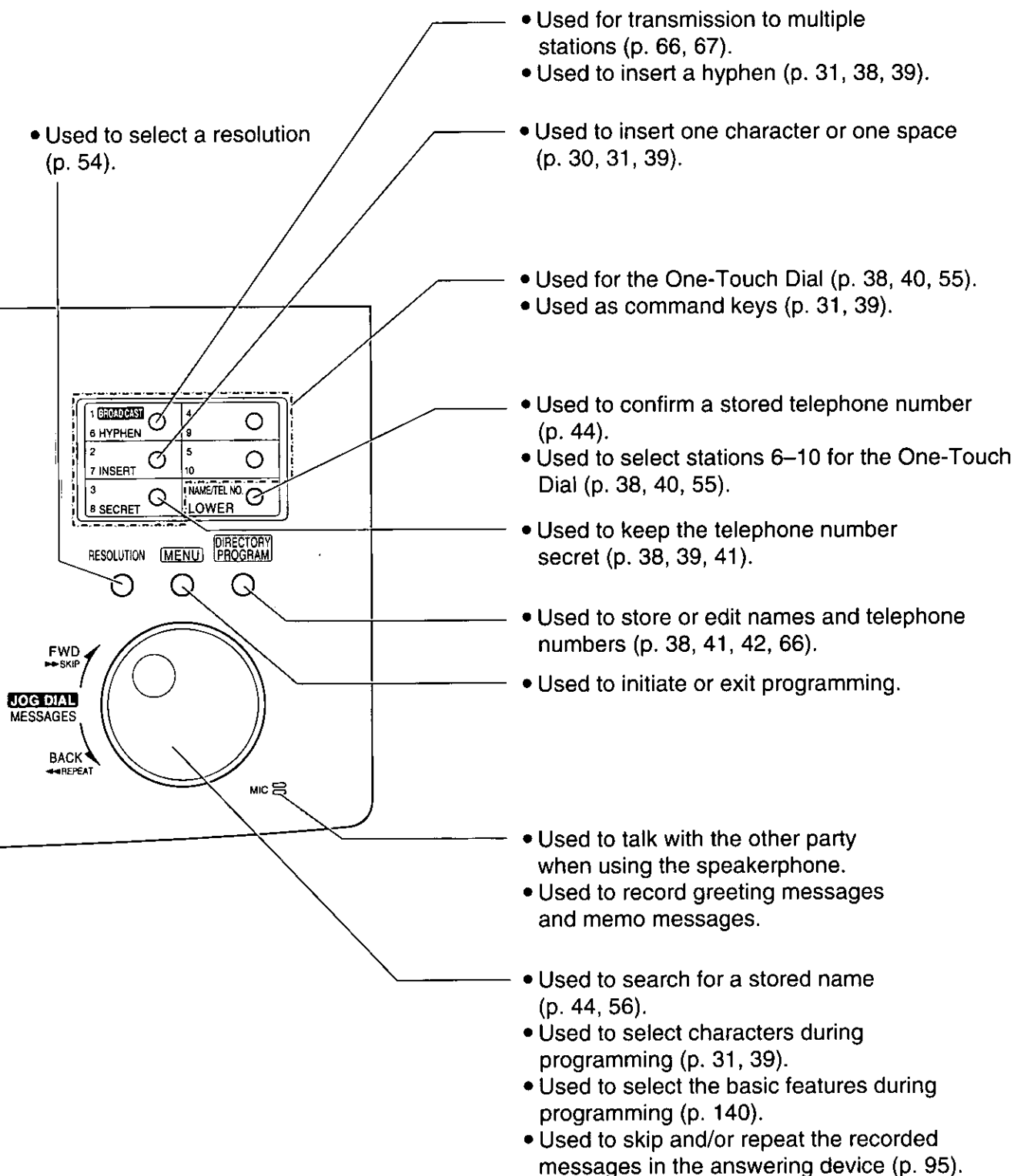

Finding the Controls

Overview

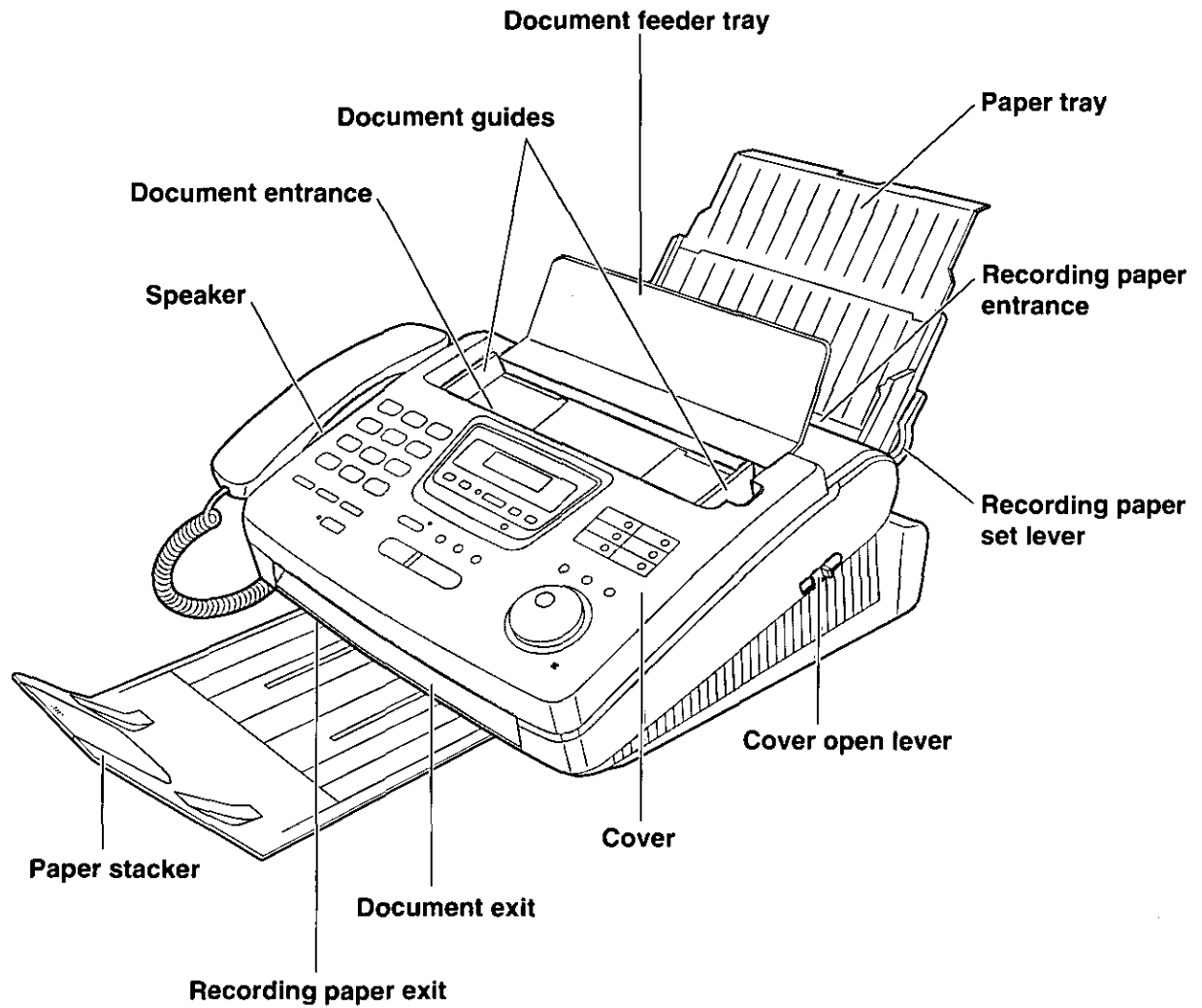

Film cartridge

The free starter film prints about 65 letter size pages. A normal film roll prints about 330 letter size pages. Purchase one of the following full size replacement film kits as soon as possible for uninterrupted use of your Panasonic plain paper fax machine.

Full size replacement film kits:

- **KX-FA135 Film cartridge** Complete kit includes: Film roll, gears and cartridge. (Prints about 330 letter size pages.)
- **KX-FA136 Replacement film** Two replacement film rolls only. Use these film rolls to refill the cartridge. (Both rolls print a total of about 660 letter size pages.)

Caution:

- The film can only be used once. When the unit displays "FILM EMPTY", refill or replace the cartridge with one of the kits above (see page 18 for ordering instructions). If the film is rewound, the print quality will be greatly reduced, and the unit may jam.

- 1** Remove the shipping tape from the unit.

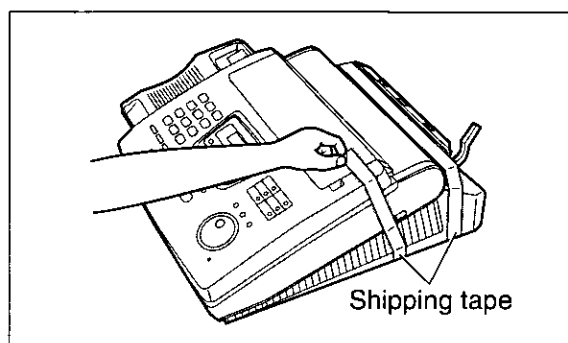

- 2** Slide the cover open lever forward.

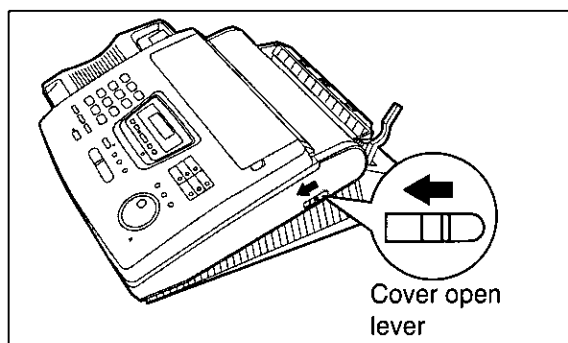

- 3** The cover is under tension to improve print quality. Pull up hard enough to open.

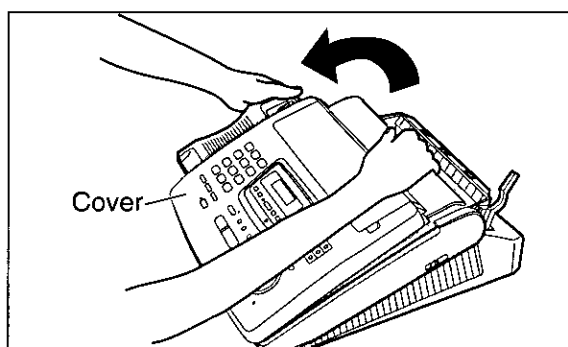

(continued)

Setup

4 Remove the leaflet from the unit.

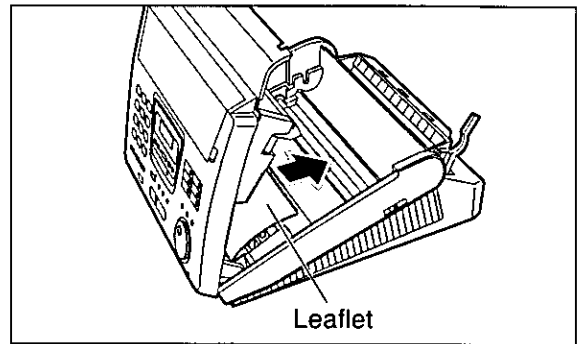

5 If the film in the film cartridge is slack, tighten it by winding the bottom side gears.

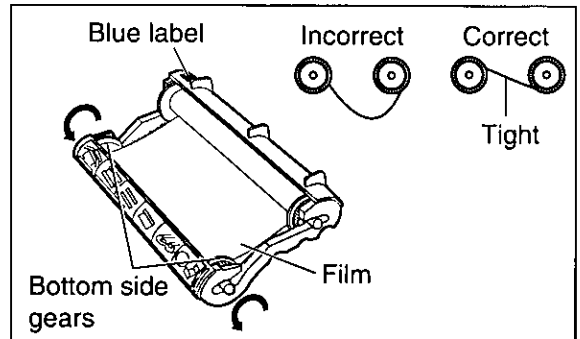

6 Install the film cartridge into the unit.

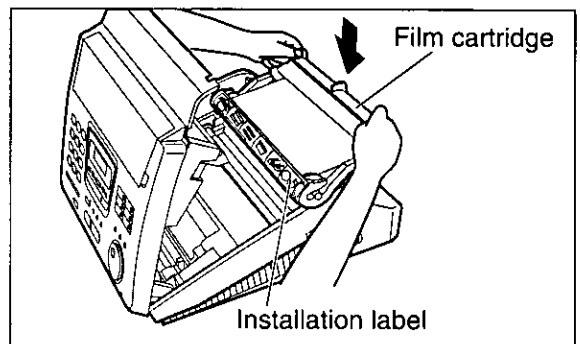

7 Make sure that the blue label on the cartridge matches the one on the unit.

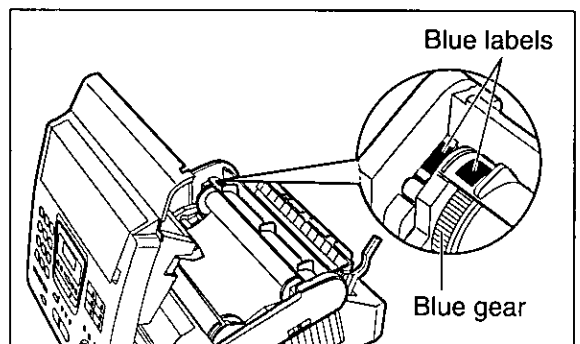

8 Close the cover securely by pushing down on both ends.

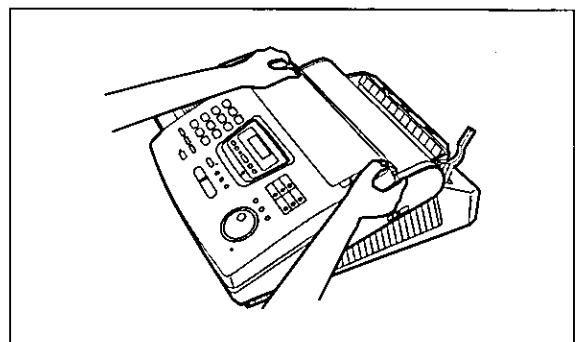

Paper stacker

- 1** Remove the shipping tape from the paper stacker.
- 2** Lift the front of the unit and insert the paper stacker into the slots.
- 3** Confirm if the paper stacker is locked into the center slots.
- 4** Slide the paper stacker until it stops.

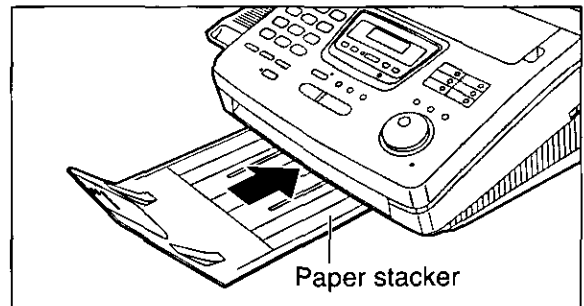
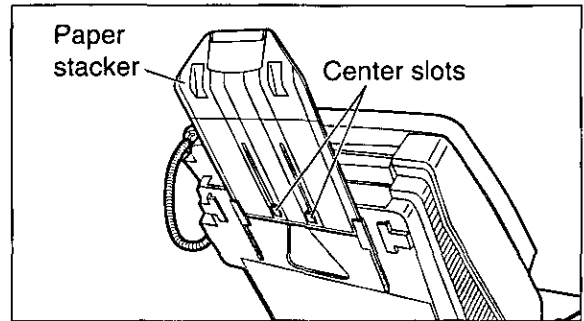
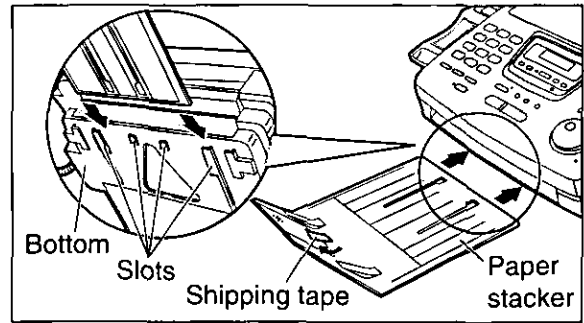

Using legal size paper

- 1** Press the dotted area on the paper stacker extender.
- 2** Open the paper stacker extender.

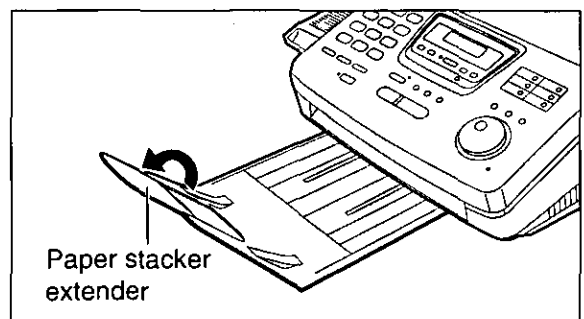
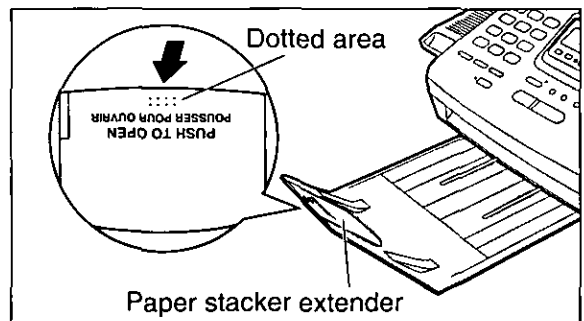

Setup

Paper tray

- 1 Open the paper tray.

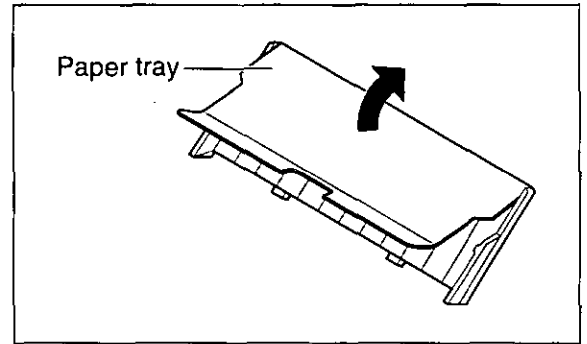

- 2 Insert the two tabs on the paper tray into the slots on the back of the unit.

- Do not place the unit in areas where the paper tray may be obstructed by a wall, etc.

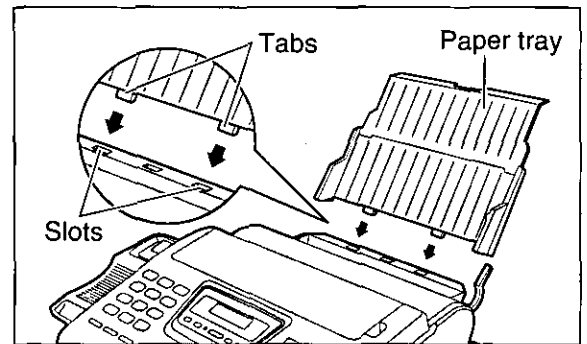

Recording paper

Letter or legal size recording paper can be loaded. The paper tray can hold up to 150 sheets of 75 g/m² (20 lb.) paper. You may use 60 g/m² to 90 g/m² (16 lb. to 24 lb.) paper.

For best results, use inkjet paper like Hammermill® Jet Print. If you use other types of paper, the print quality may be affected.

- 1 Pull the recording paper set lever forward.

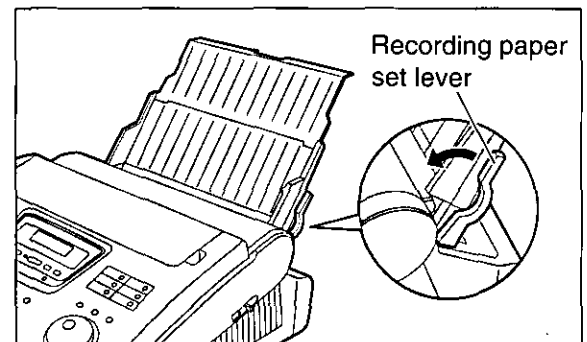

- 2** Fan the stack of paper to prevent a paper jam and insert the paper into the paper tray.
- The height of the stack of the paper should not exceed the upper limit on the paper tray, otherwise the paper may jam or multi-feed.
 - The paper should not be over the tab.
 - If the paper is not inserted correctly, readjust the paper or the paper may jam.

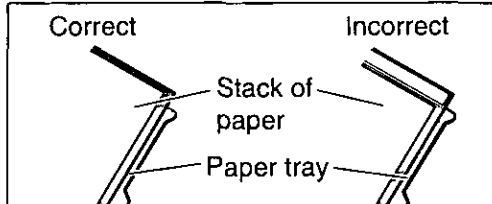
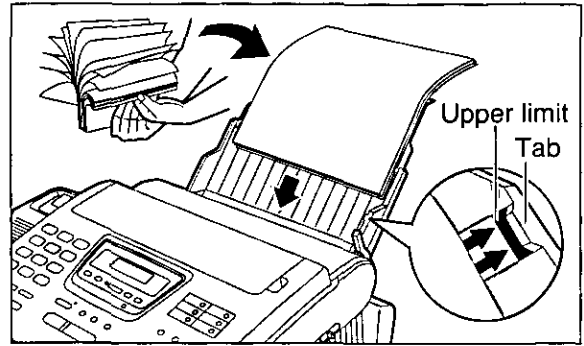

- 3** Move the recording paper set lever back.

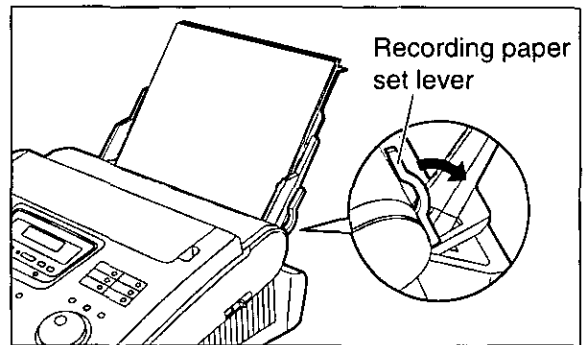

Note:

- Avoid paper with a cotton and/or fiber content that is over 20%, such as letterhead paper or those used for resumes.
- Do not use different types or thicknesses of paper in the paper tray at the same time. This may cause a paper jam.
- Avoid extremely smooth or shiny paper that is highly textured. Also avoid paper that is coated, damaged or wrinkled.
- Avoid double-sided printing.
- Do not use paper printed from this unit for double-sided printing with other copiers or printers, or a paper jam may occur.

Adding paper to the paper tray

1. Pull the recording paper set lever forward.
 - The unit will beep and the following message will be displayed.

Display: CHECK LEVER

2. Remove the installed paper.
3. Add paper to the removed paper and straighten it.
4. Fan the stack of paper and insert it into the paper tray.
5. Move the recording paper set lever back.

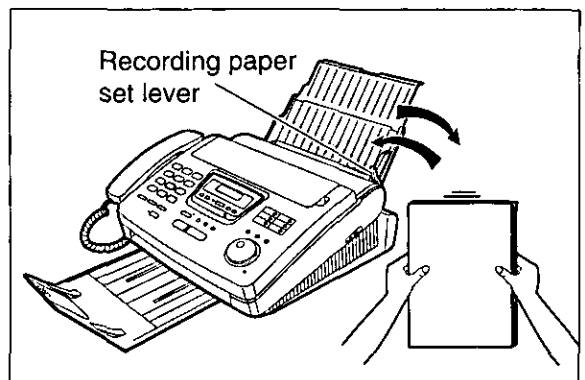

Setup

Connections

- 1 Connect the handset cord.
- 2 Connect the telephone line cord.
- 3 Connect the power cord.
 - When the power is turned on for the first time, the unit will print some basic information.

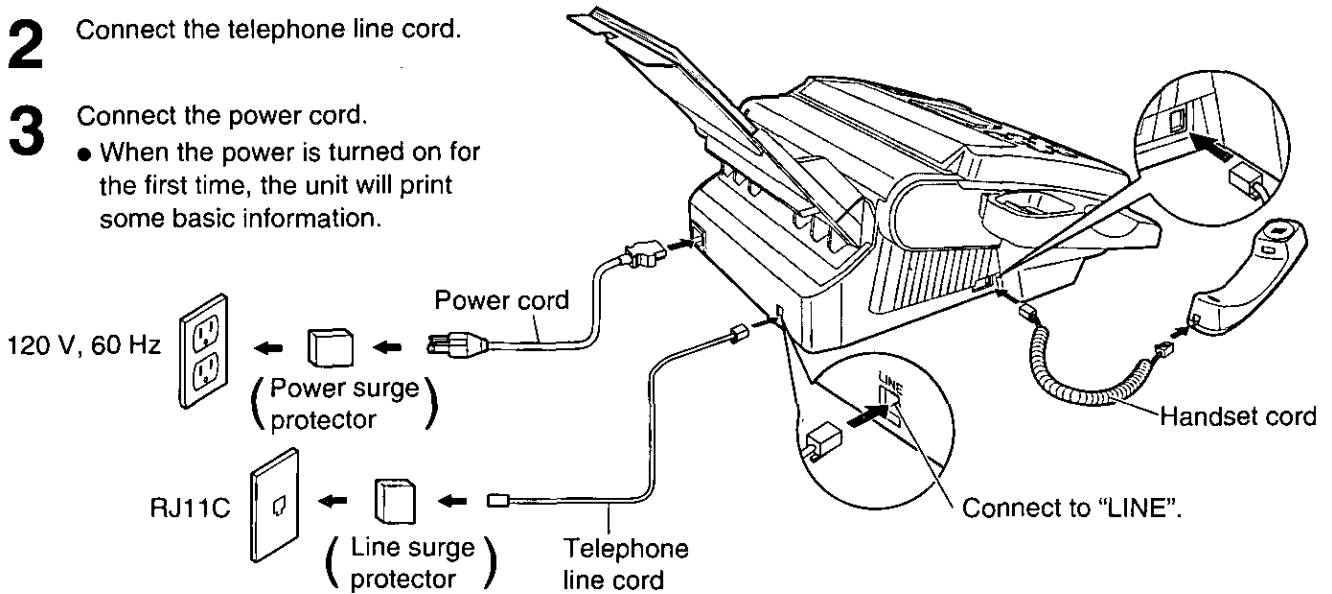

Note:

- The warranty does not cover damage due to power line surges or lightning. For additional equipment protection, we recommend the use of a surge protector. The following types are available; TELESPIKE BLOK MODEL TSB (TRIPPE MFG. CO.), SPIKE BLOK MODEL SK6-0 (TRIPPE MFG. CO.), SUPER MAX (PANAMAX) or MP1 (ITW LINX).
- When you operate this product, the power outlet should be near the product and easily accessible.
- If the following message is displayed when the unit is plugged in, the recording paper set lever will be released.

Display:

Move the lever back (see step 3 on page 27).

Automatic dialing mode setting

- When the telephone line cord and the power cord are connected, the unit will automatically start to detect the dialing mode.

Display:

Wait until one of the following messages is displayed.

— If your line has touch tone service:

— If your line has rotary pulse dial service:

- If the power cord is disconnected or a power failure occurs, the unit will detect the dialing mode again when power is restored.
- You can change the dialing mode setting manually. See page 37.
- If you connect the power cord before connecting the telephone line cord, the following messages will be shown alternately.



Connect the telephone line cord.

Date and time, your name and facsimile telephone number

You should program the date and time, your logo and facsimile telephone number. This information will be printed on each page transmitted from your unit, fulfilling the requirements of the Telephone Protection Act of 1991.

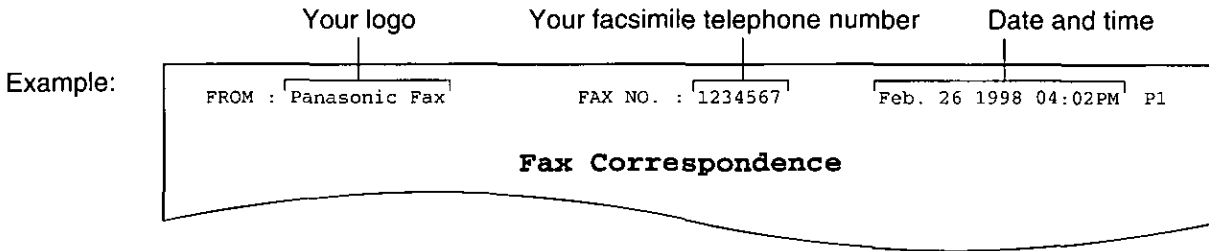

Setting the date and time

1 Press **MENU**.
Display: 1.SYSTEM SET UP

2 Press **▣**, then **0 1**.
SET DATE & TIME

3 Press **START/COPY/SET**.
M: 01 / D: 01 / Y: 98
Cursor

4 Enter the correct month/day/year by selecting each 2 digits using the dial keypad or **JOG DIAL**.
If using **JOG DIAL**, press **▶** to move the cursor.
Example (using the dial keypad): Aug. 10, 1998
Press **0 8 1 0 9 8**.
M: 08 / D: 10 / Y: 98

5 Press **START/COPY/SET**.
TIME: 12:00AM

6 Enter the correct hour/minute by selecting each 2 digits using the dial keypad or **JOG DIAL**.
If using **JOG DIAL**, press **▶** to move the cursor.
Press ***** to select "AM" or "PM".
Example (using the dial keypad): 3:15PM
1. Press **0 3 1 5**.

TIME: 03:15AM

2. Press ***** until "PM" is displayed.
TIME: 03:15PM

7 Press **START/COPY/SET**.
SETUP ITEM []

8 Press **MENU**.

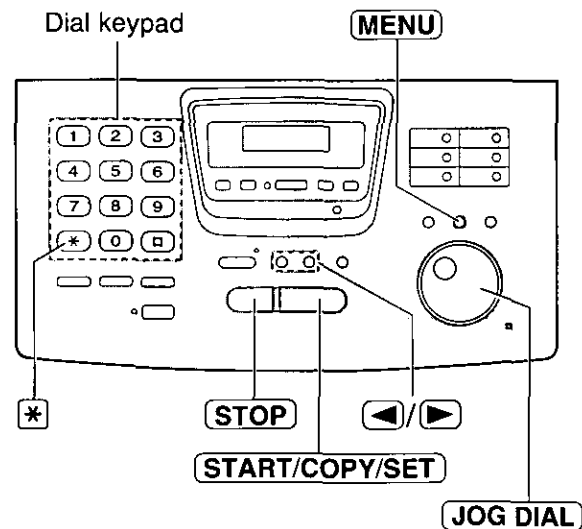

Note:

- The ***** key can be used to select "AM" or "PM" wherever the cursor is located.
- The accuracy of the clock is approximately ± 60 seconds a month.

To correct a mistake

- Press **◀** or **▶** to move the cursor to the incorrect number, then make the correction.
- If you press **STOP** while programming, the display will return to the previous one.

Setup

Setting your logo

The logo can be your company, division or name.

1 Press **MENU**.
Display: 1. SYSTEM SET UP

2 Press **□**, then **0 2**.
YOUR LOGO

3 Press **START/COPY/SET**.
LOGO=

4 Enter your logo, up to 30 characters, by using the dial keypad or **JOG DIAL** (see the next page).

Example (using the dial keypad): Bill

1. Press **2** twice. LOGO=B
Cursor

2. Press **4** six times. LOGO=Bi

3. Press **5** six times. LOGO=Bi

4. Press **▶** to move the cursor to the next space and press **5** six times.

LOGO=Bill

5 Press **START/COPY/SET**.
SETUP ITEM []

6 Press **MENU**.

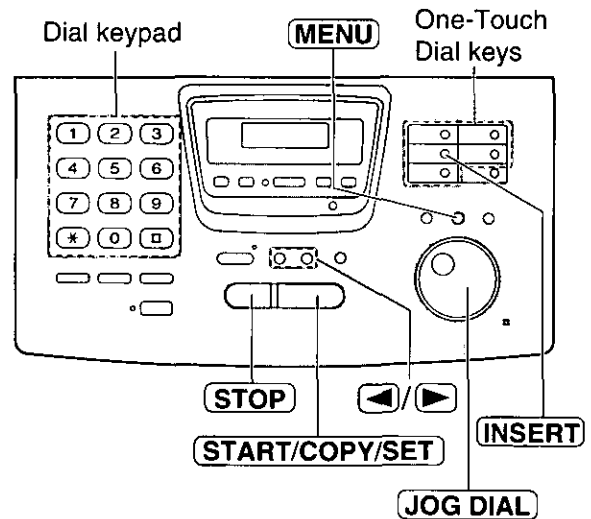

To correct a mistake

- Press **◀** or **▶** to move the cursor to the incorrect character, then make the correction.

To delete a character

- Move the cursor to the character you want to delete and press **STOP**.

To insert a character

1. Press **◀** or **▶** to move the cursor to the position to the right of where you want to insert the character.
2. Press **INSERT** (One-Touch Dial key 2) to insert a space and enter the character.

To select characters with the dial keypad

Pressing the dial keys will select a character as shown below.

Keys	Characters
Dial keys	① 1 [] { } + - / = , . _ ' : ; ?
	② A B C a b c 2
	③ D E F d e f 3
	④ G H I g h i 4
	⑤ J K L j k l 5
	⑥ M N O m n o 6
	⑦ P Q R S p q r s 7
	⑧ T U V t u v 8
	⑨ W X Y Z w x y z 9
	⑩ 0 () < > ! " # \$ % & ¥ * @ ^ ' →
One-Touch Dial keys	1 HYPHEN key (Used to insert a hyphen.)
	2 INSERT key (Used to insert one character or one space.)
Arrow keys	◀ key (Used to move the cursor to the left.)
	▶ key (Used to move the cursor to the right.) To enter another character using the same number key, move the cursor to the next space.

To select characters using the JOG DIAL

Instead of pressing the dial keys, you can select characters using the JOG DIAL.

1. Rotate **JOG DIAL** until the desired character is displayed.
2. Press to move the cursor to the next space.
 - The character displayed in step 1 is inserted.
3. Return to step 1 to enter the next character.

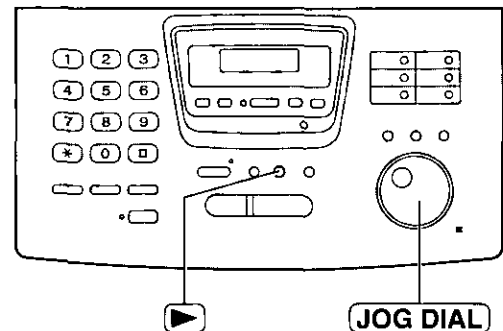

Display order of characters

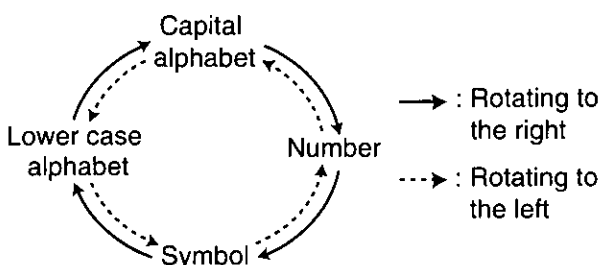

Setup

Setting your facsimile telephone number

- 1 Press **MENU**.
Display: 1.SYSTEM SET UP
- 2 Press **□**, then **0 3**.
YOUR FAX NO.
- 3 Press **START/COPY/SET**.
NO. =
- 4 Enter your facsimile telephone number up to 20 digits using the dial keypad or **JOG DIAL**.
If using **JOG DIAL**, press **▶** to move the cursor.
Example: NO. =1234567
- 5 Press **START/COPY/SET**.
SETUP ITEM []
- 6 Press **MENU**.

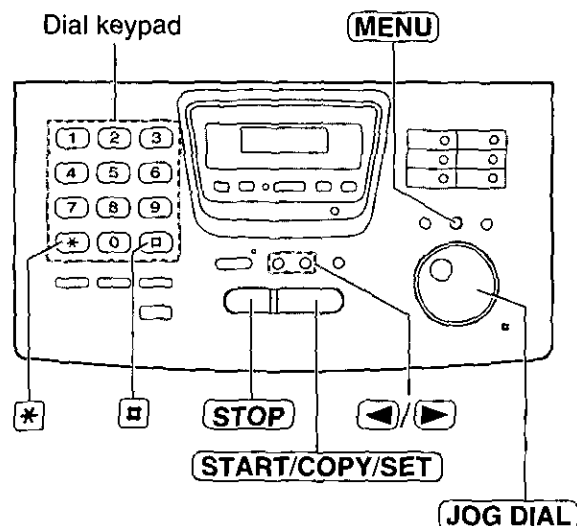

Note:

- The **□** button replaces a digit with a space and the ***** button a "+".

Example (using the dial keypad): +234 5678

Press ***234□5678**.

To correct a mistake

- Press **◀** or **▶** to move the cursor to the incorrect number, then make the correction.

To delete a number

- Move the cursor to the number you want to delete and press **STOP**.

Adjusting volumes

Ringer volume

4 levels (high/middle/low/off) are available.

While the unit is idle, press or .

■ To turn the ringer off:

1. Press repeatedly until the following message is displayed.

Display:



2. Press .

- To turn the ringer back on, press .

■ While the ringer volume is set to off:

The display will show the following message.

When a call is received, the unit will not ring and will display the following.

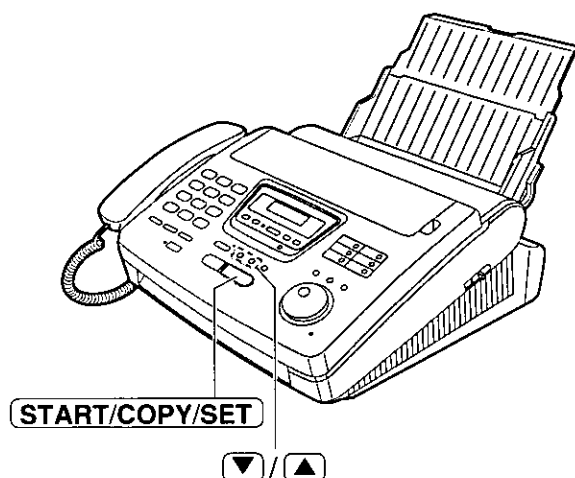

Handset receiver volume

5 levels (high to low) are available.

While using the handset, press or .

Speaker volume

8 levels (high to low) are available.

While using the speakerphone, press or .

Fax voice guidance volume

9 levels (high to off) are available.

While listening to the fax voice guidance, press or (see page 122).

Answering device volume

9 levels (high to off) are available.

While listening to the recorded messages, press or .

Making and Answering Calls

Voice calls - making

- 1 Press **DIGITAL SP-PHONE** or lift the handset.

Display: TEL=

- 2 Dial the telephone number.

Example: TEL=2345678

- If you misdial, hang up and dial again.

- 3 When the other party answers, talk into the microphone or handset.

- 4 When finished, press **DIGITAL SP-PHONE** or hang up the handset.

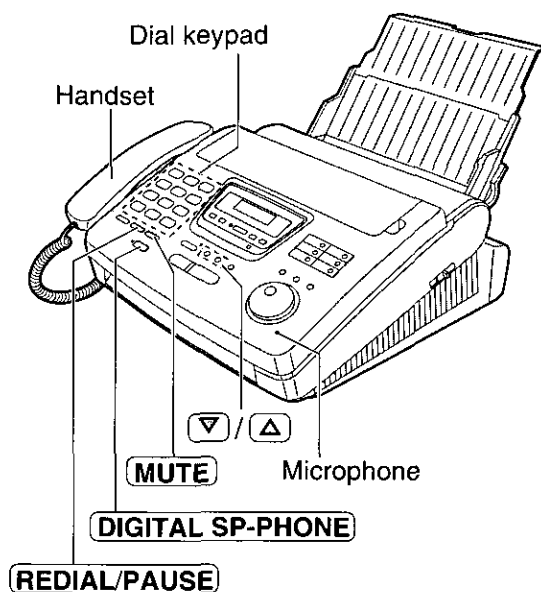

To redial the last number

1. Press **DIGITAL SP-PHONE** or lift the handset.

2. Press **REDIAL/PAUSE**.

- If the line is busy when using the **DIGITAL SP-PHONE** button, the unit will automatically redial the number up to 14 times.
- During redial, the following will be displayed.

Display: WAITING REDIAL

To mute your voice to the other party

1. Press **MUTE** during a telephone conversation.

Display: <MUTE>

- The other party cannot hear you, but you can hear them.

2. To resume the conversation, press **MUTE**.

Hints for the speakerphone operation

- Use the speakerphone in a quiet room.
- If you have difficulty hearing the other party, adjust the volume using **▽** or **△**.
- If you and the other party speak at the same time, parts of your conversation will be cut off.
- To switch to the handset, lift the handset. To switch back to the speakerphone, press **DIGITAL SP-PHONE**.

Voice calls - answering

- 1** When the unit rings, press **DIGITAL SP-PHONE** or lift the handset.
- 2** When finished, press **DIGITAL SP-PHONE** or hang up the handset.

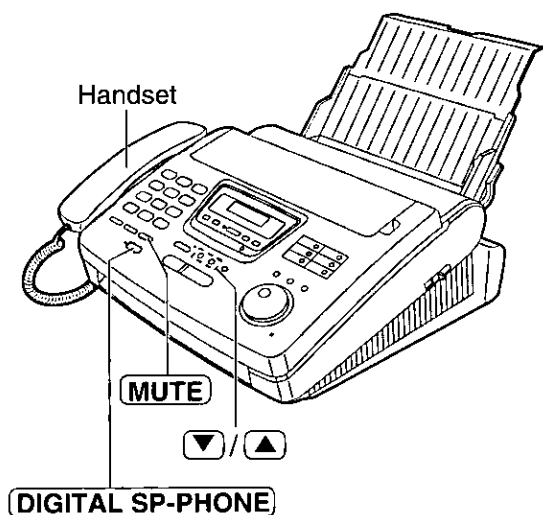

Making and Answering Calls

TONE, FLASH and PAUSE buttons

TONE button

The **TONE** (*) button is used for rotary pulse dial services and allows you to temporarily change from the pulse to tone mode during a dialing operation. When you hang up, the unit will automatically return to the pulse mode.

FLASH button

The **FLASH** button functions as the hookswitch on a regular telephone. If you misdial a telephone number, press the **FLASH** button firmly.

The **FLASH** button also allows you to use special features of a host exchange (if connected) or local telephone company services such as call waiting. For further details, contact your host exchange supplier or local telephone company.

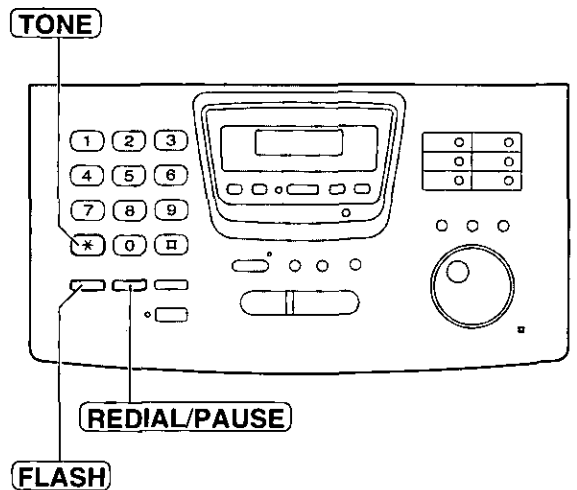

Note:

- TONE, FLASH and PAUSE can be stored into a telephone number in the One-Touch Dial and the JOG DIAL directory.

Entering pauses

When the **REDIAL/PAUSE** button is pressed during dialing, a pause will be inserted. Pressing **REDIAL/PAUSE** once creates a 5 second pause.

Example 1:

When your unit is connected to a host exchange, insert a pause before the telephone number to get an outside line.

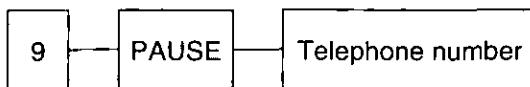

Line access code

Example 2:

If a transmission error occurs during an overseas transmission, add two pauses at the end of the telephone number.

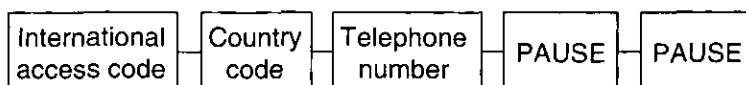

Dialing mode (touch tone or pulse) =====

When the unit is turned on, the unit will automatically set the dialing mode to "TONE" or "PULSE" if this feature is set to "AUTO".

If you cannot dial, change the dialing mode setting to "TONE" or "PULSE" by following the instructions below.

- 1 Press **MENU**.
Display: 1.SYSTEM SET UP
- 2 Press **□**, then **1** **3**.
DIALING MODE
- 3 Press **START/COPY/SET**.
MODE=AUTO ▼▲
- 4 Press ▼ or ▲ to select the desired setting.
- 5 Press **START/COPY/SET**.
SETUP ITEM []
- 6 Press **MENU**.

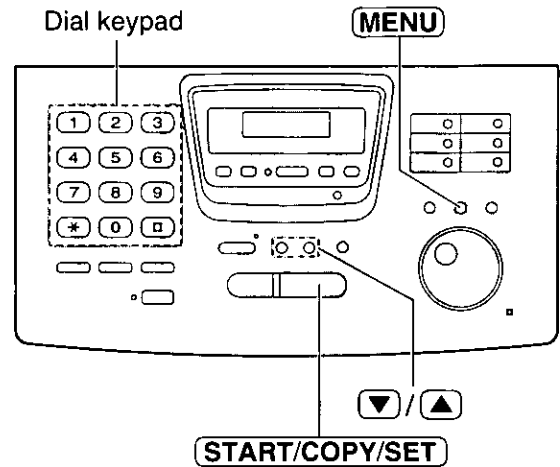

Note:

- If you change to a different telephone company and this company uses a different dialing mode, reset the dialing mode.

One-Touch Dial

Storing names and telephone numbers in the One-Touch Dial

The unit's memory allows you to use the One-Touch Dial for rapid access to your most frequently dialed numbers. 10 stations are available.

- The One-Touch Dial key 1 can be used as One-Touch Dial key 1 (DIAL MODE) or as a broadcast key (BROADCAST). Both functions cannot be used at the same time. For the broadcast function, see pages 66 and 67.

1 Press **DIRECTORY PROGRAM**.

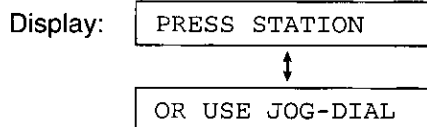

2 For stations 1–5
Press one of the One-Touch Dial keys.

- If you select One-Touch Dial key 1, select "DIAL MODE" by pressing . Then press **START/COPY/SET** to go to the next prompt.

For stations 6–10

Press **LOWER**, then press one of the One-Touch Dial keys.

3 Enter the station name, up to 10 characters, by following the instructions on the next page.

Example:

4 Press **START/COPY/SET**.

Example:

5 Enter the telephone number up to 30 digits.
• To enter a hyphen in a telephone number, press **HYPHEN** (One-Touch Dial key 1).

Example:

6 Press **START/COPY/SET**.

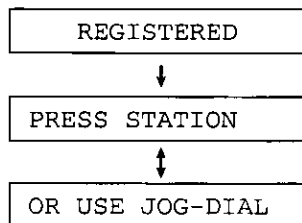

- To program other stations, repeat steps 2 to 6.

7 Press **DIRECTORY PROGRAM** to exit the program.

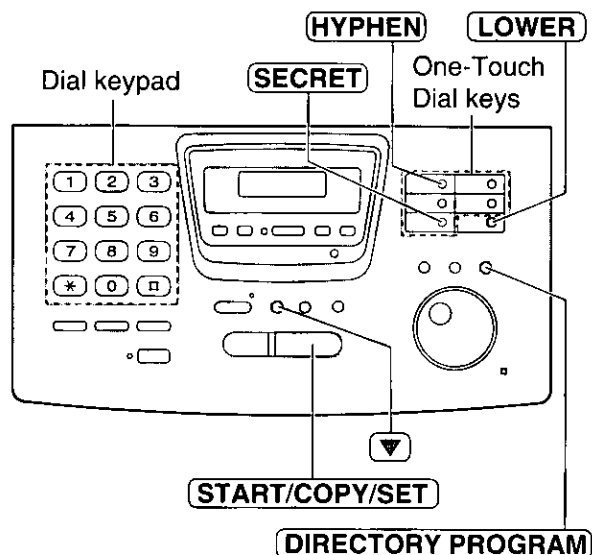

Helpful hints:

- To confirm the stored telephone numbers and station names, print a telephone number list (see page 121).
- The stored names in the One-Touch Dial can be searched for using the JOG DIAL directory.

Example:

To keep the telephone number secret

Press **SECRET** (One-Touch Dial key 3) after entering the telephone number in step 5.

- Once a secret number is set, it cannot be viewed.
- The telephone number will not appear on the telephone number list.
- Pressing **SECRET** does not count as a digit.

To edit a stored station name and number

Enter the desired name in step 3.

Enter the desired number in step 5.

To erase a stored station name and number, see page 43.

To select characters with the dial keypad

Pressing the dial keys will select a character as shown below.

Keys		Characters
Dial keys	①	1 [] { } + - / = , . - ' : ; ?
	②	A B C a b c 2
	③	D E F d e f 3
	④	G H I g h i 4
	⑤	J K L j k l 5
	⑥	M N O m n o 6
	⑦	P Q R S p q r s 7
	⑧	T U V t u v 8
	⑨	W X Y Z w x y z 9
	⑩	0 () < > ! " # \$ % & ¥ * @ ^ ' →
One-Touch Dial keys	①	HYPHEN key (Used to insert a hyphen.)
	②	INSERT key (Used to insert one character or one space.)
	③	SECRET key (Used to keep the telephone number secret.)
Arrow keys	◀ ▶	◀ key (Used to move the cursor to the left.)
	▶ ↻	▶ key (Used to move the cursor to the right.) To enter another character using the same number key, move the cursor to the next space.

Telephone

Note:

- A hyphen entered in a telephone number is counted as two digits.

To select characters using the JOG DIAL

Instead of pressing the dial keys, you can select characters using the JOG DIAL.

1. Rotate **JOG DIAL** until the desired character is displayed.
2. Press ▶ to move the cursor to the next space.
 - The character displayed in step 1 is inserted.
3. Return to step 1 to enter the next character.

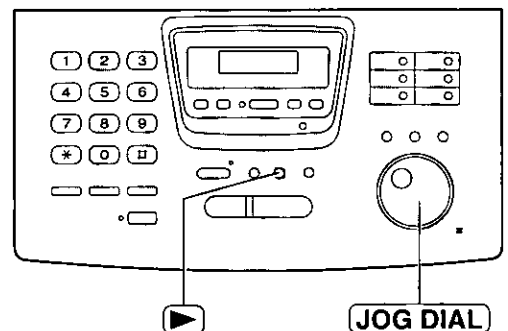

Display order of characters

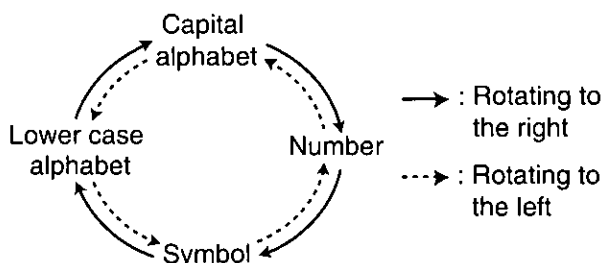

One-Touch Dial

Making a voice call using the One-Touch Dial

Before using this feature, program the desired names and telephone numbers into the One-Touch Dial (see page 38).

- 1 Press **DIGITAL SP-PHONE** or lift the handset.

Display: TEL=

- Confirm that there are no documents in the document feeder tray.

- 2 For stations 1–5
Press the desired One-Touch Dial key.

For stations 6–10

Press **LOWER**, then press the desired One-Touch Dial key.

Example: TEL=<John>

- 3 When the other party answers, talk into the microphone or handset.

- 4 When finished, press **DIGITAL SP-PHONE** or hang up the handset.

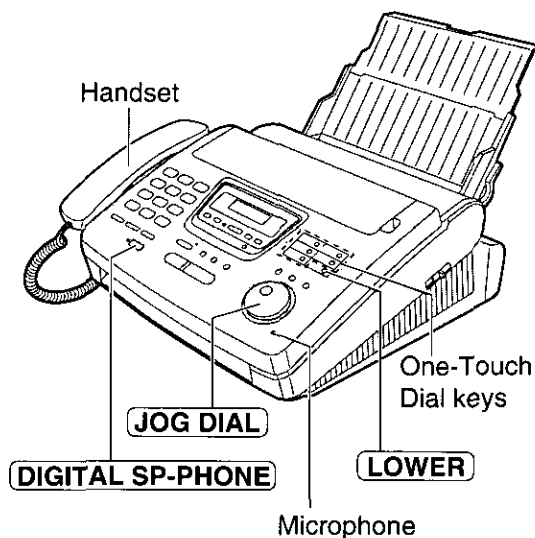

Helpful hints:

- To confirm the items stored in the One-Touch Dial, print a telephone number list (see page 121).
- You can use the JOG DIAL directory to select the station name instead of using the One-Touch Dial keys. Rotate **JOG DIAL** until the desired name is displayed, then press **DIGITAL SP-PHONE** or lift the handset.

Storing names and telephone numbers in the JOG DIAL directory

For rapid access to frequently dialed numbers, the unit also provides a JOG DIAL directory (100 stations for the KX-FP270, 60 stations for the KX-FP265) in addition to the One-Touch Dial. For your convenience, the following 2 stations have been preprogrammed in the JOG DIAL directory.

HELP-FAX (1-800-435-7329): If you cannot correct the problem after trying the help function (see page 19), call using this station (see page 44).

IQ-FAX-CS (IQ-FAX Customer Service Center) (1-888-332-9728): If you have a problem with IQ-FAX, call using this station (see page 44).

If you do not need the above stations, you can edit or erase them (see pages 42 and 43).

1 Press **DIRECTORY PROGRAM**.

Display: **PRESS STATION**

↑

OR USE JOG-DIAL

2 Rotate **JOG DIAL** until the following is displayed.

NAME=

3 Enter the name, up to 10 characters, by following the instructions on page 39.

Example: **NAME=Alice**

4 Press **START/COPY/SET**.

NO. =

5 Enter the telephone number up to 30 digits.

Example: **NO. =5552233**

6 Press **START/COPY/SET**.

REGISTERED

↓

NAME=

• To program other items, repeat steps 3 to 6.

7 Press **DIRECTORY PROGRAM** to exit the program.

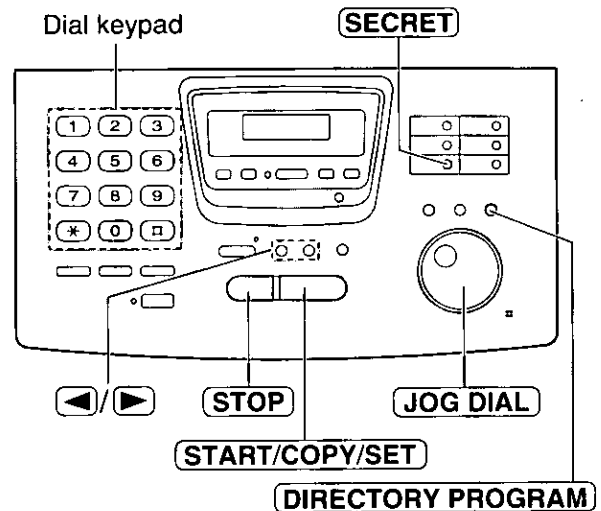

Note:

- To confirm the stored names and telephone numbers, print a telephone number list (see page 121).
 - You can store items during a telephone conversation.
 - When the following message is displayed in step 6, you can only store 5 items.
- Display: **SPACE= 5 DIRS.**
- If the unit shows "JOG-DIAL FULL" in step 1, there is no space to store new stations. Edit or erase unnecessary stations (see pages 42 and 43).
 - By rotating **JOG DIAL** to the right, stored items can be displayed. The order is as follows: alphabet, number, symbol and telephone number (when a name is not stored).

To correct a mistake

- Press **◀** or **▶** to move the cursor to the incorrect character, then make the correction.

To delete a character

- Move the cursor to the character you want to delete and press **STOP**.

To keep the telephone number secret

- Press **SECRET** (One-Touch Dial key 3) after entering the telephone number in step 5.
- Once a secret number is set, it cannot be viewed.
 - The telephone number will not appear on the telephone number list.
 - Pressing **SECRET** does not count as a digit.

JOG DIAL

Editing a stored name and number

1 Rotate **JOG DIAL** until the desired name is displayed.

Example:

2 Press **DIRECTORY PROGRAM**.

3 Press ***** to select "EDIT".

- If you do not need to edit the name, skip to step 5.

4 Edit the name by following the instructions on page 39.

5 Press **START/COPY/SET**.

Example:

- If you do not need to edit the telephone number, skip to step 7.

6 Edit the telephone number. For further details, see page 41.

7 Press **START/COPY/SET**.

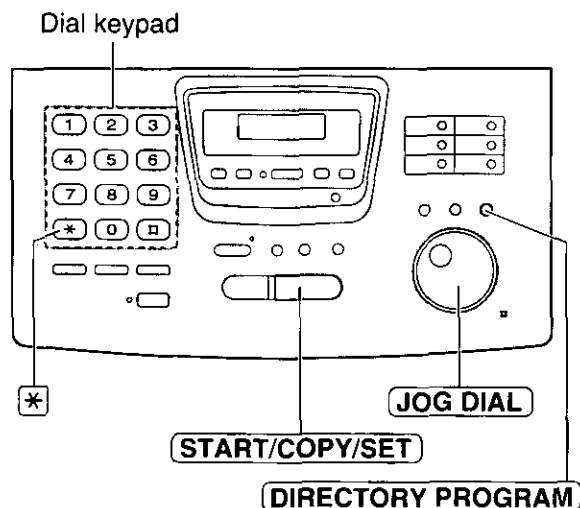

Erasing a stored name and number

You can also erase a name and number stored in the One-Touch Dial by following the instructions below.

- 1** Rotate **JOG DIAL** until the desired name is displayed.

Example: Smith
- 2** Press **DIRECTORY PROGRAM**.

EDIT= * DELETE=#
- 3** Press **#** to select "DELETE".

DELETE OK?

↑

YES: PRESS SET

 - If you do not want to erase the item, press **STOP**.
- 4** Press **START/COPY/SET**.

DELETED

 - The stored name and number are deleted.

Note:

- You can use the **ERASE** key to erase a name and number. Press **ERASE** after rotating **JOG DIAL** in step 1, then press **START/COPY/SET**.

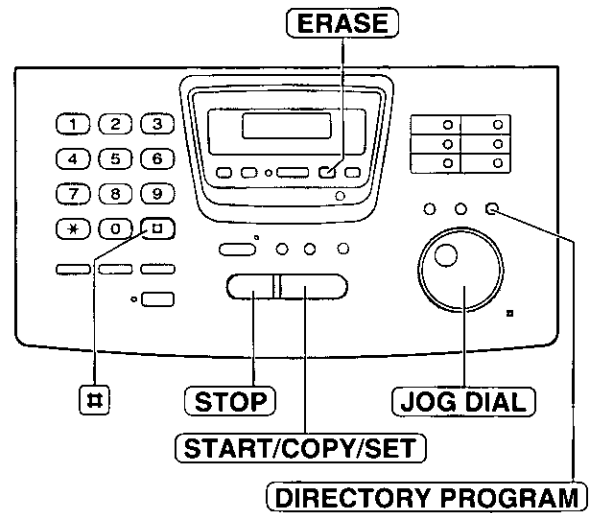

Making a voice call using the JOG DIAL directory

Before using this feature, program the desired names and telephone numbers into the directory (see page 41).

- 1 Rotate **JOG DIAL** until the desired name is displayed.

Example:

- 2 Press **DIGITAL SP-PHONE** or lift the handset.
 - The unit will start dialing automatically.

- 3 When the other party answers, talk into the microphone or the handset.

- 4 When finished, press **DIGITAL SP-PHONE** or hang up the handset.

Helpful hint:

- To confirm the items stored in the directory, print a telephone number list (see page 121).

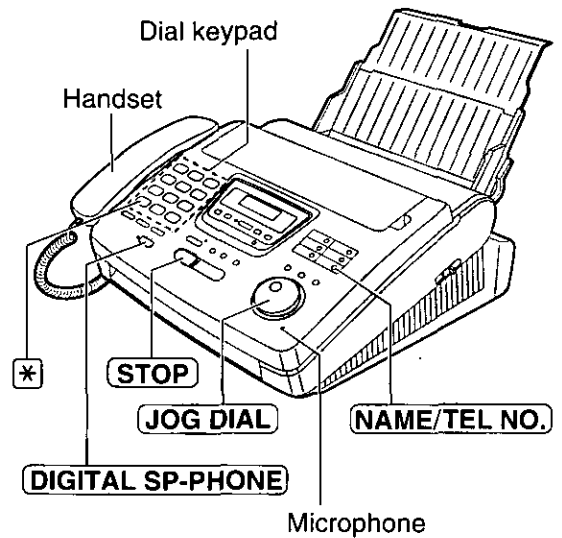

Note:

- If the desired name has not been stored, press **STOP** and dial the number manually.

To search for a name by the initial

Example: When you want to search for the name "Lisa"

1. Rotate **JOG DIAL** until any name is displayed.

Example:

2. Press **5** repeatedly until any name with the initial "L" is displayed (see the character table on page 39).

3. Rotate **JOG DIAL** to the right until "Lisa" is displayed.

- To stop the operation, press **STOP**.

4. Press **DIGITAL SP-PHONE** or lift the handset, and the unit will automatically dial the number.

Note:

- When you want to search for symbols (not alphabet or numbers), press the ***** key in step 2.

To confirm a stored telephone number

1. Rotate **JOG DIAL** until the desired name is displayed.

Example:

2. Press **NAME/TEL NO.**

- To stop the operation, press **STOP**.

3. Press **DIGITAL SP-PHONE** or lift the handset, and the unit will automatically dial the number.

Caller ID service from the phone company

This unit is compatible with a Caller ID service offered by your local telephone company. To use this feature, you must subscribe to a Caller ID service.

Caller ID and its capabilities

Caller ID allows you to view the name or telephone number of the caller before you answer the call. The calling party information (name has priority) will be displayed after the first ring.

By using Caller ID, you have the option of whether or not to answer the call depending on the caller.

The unit also stores the caller's information and prints a list automatically after every 35 calls.

- To set this feature, see page 52.
- To print out the Caller ID list manually, see page 121.

Important:

- When you subscribe to a Caller ID service, set the following ring count settings to 2 or more rings:
 - TAD/FAX mode ring count (p. 105)
 - FAX ONLY mode ring count (p. 74), and
 - TEL/FAX delayed ring count (p. 81).

How Caller ID is displayed

- 1 When a call is received, the display will show the caller's name after the first ring.

Example: ROGER DAVIS

- 2 You can display the caller's name and number respectively by pressing NAME/TEL NO..

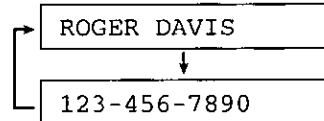

- 3 After hanging up, the caller's information (name, telephone number and the time of the call) will automatically be saved in the Caller ID list (see page 52).

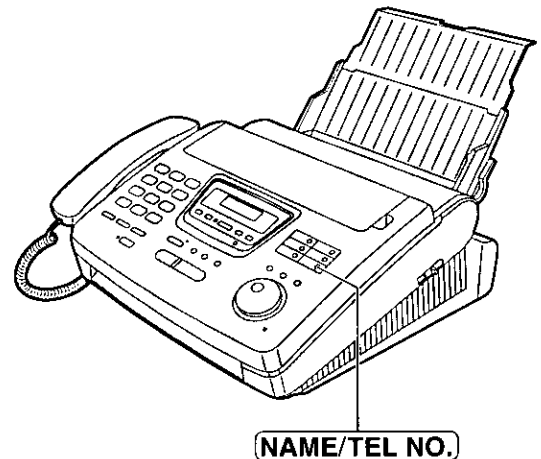

Note:

- If the caller's name and number cannot be received, the following message will be displayed.

Display: NO NAME RCVD

- When the unit is connected to a PBX system, you may not receive the caller's information. Consult with your PBX supplier.
- The Caller ID service is currently provided in calling areas by caller identification technology. When the caller's information cannot be received, the display will show as follows.
 - If the caller dialed from an area which does not provide the Caller ID service:

OUT OF AREA

- If the caller has requested not to send their information:

PRIVATE CALLER

- If the caller made a long distance call:

LONG DISTANCE

Telephone

Caller ID

Viewing the Caller ID list on the display

The unit stores the caller's information and makes a list of up to 35 callers in chronological order. When the memory is full and the unit receives a new call, the oldest data will be automatically erased.

With the Caller ID list, the following convenient features are available.

- Viewing who has called you on the display (See below.)
- Dialing a telephone number from the list (See page 47.)
- Storing a telephone number for automatic dialing from the list (See page 48.)
- Printing out a Caller ID list (See page 121.)

1 Press **CALLER ID SEARCH**.

Example: 2 NEW CALLS



Display: USE JOG-DIAL

2 Rotate **JOG DIAL** to search the Caller ID list (see below).

3 If you want to know the caller's phone number and the date/time of the call, press **NAME/TEL NO.** repeatedly while the display is showing the desired name.

- The display will alternate the name, number and date/time by pressing **NAME/TEL NO.**.

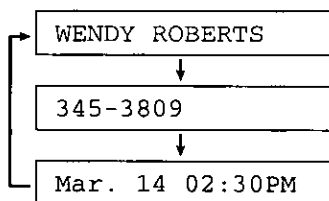

4 Press **STOP** to exit the Caller ID list.

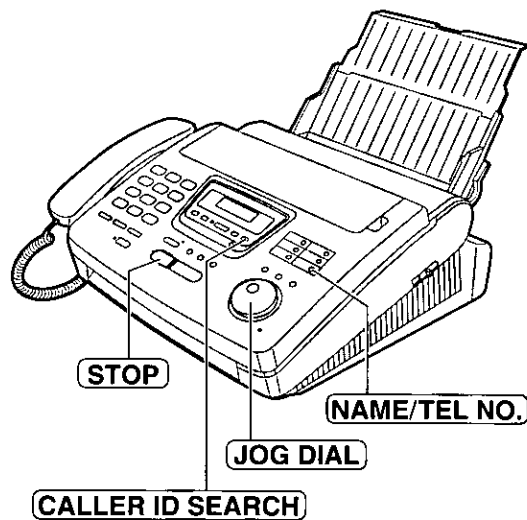

Ex. When you search from the most recent call/oldest call

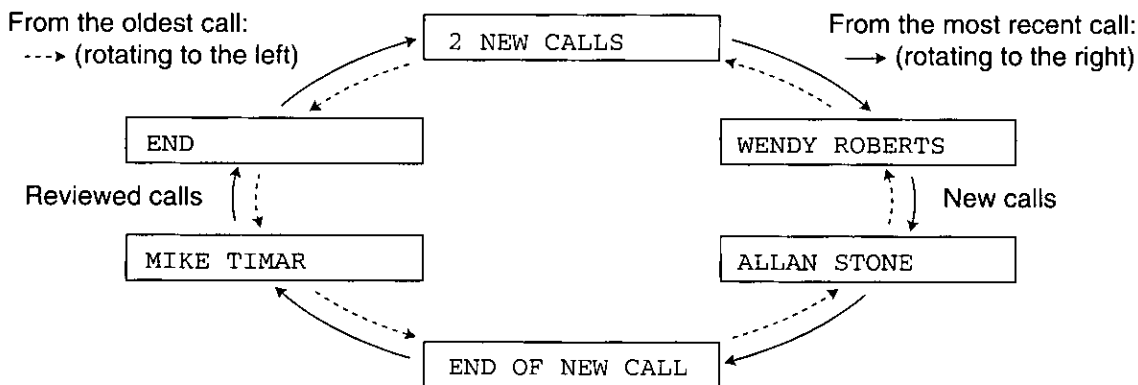

Note:

- To move between calls, rotate **JOG DIAL**.
- The display will show "END OF NEW CALL" after the last new call in the list.
- The display will show "END" after the last call in the list.
- If the display shows "NO CALLER DATA" and a beep sounds, the Caller ID list is empty.

Calling back from the Caller ID list

You can easily call back a telephone number recorded in the Caller ID list.

Important:

- This feature is not available in the following cases.
 - The telephone number includes data other than numbers (ie., * or #).
 - The telephone number information was not received.

- 1 Press **CALLER ID SEARCH**.
 Example:

2 NEW CALLS

 ↓
 Display:

USE JOG-DIAL

- 2 Rotate **JOG DIAL** until the desired name or telephone number is displayed.
 Example:

ALLAN STONE

- 3 Press **DIGITAL SP-PHONE** or lift the handset.
- 4 When finished, press **DIGITAL SP-PHONE** or hang up the handset.

Note:

- You can send a fax by pressing **START/COPY/SET** with a document on the document feeder tray after step 3.
- If a telephone number is not displayed when pressing **NAME/TEL NO.**, you cannot call back that caller.

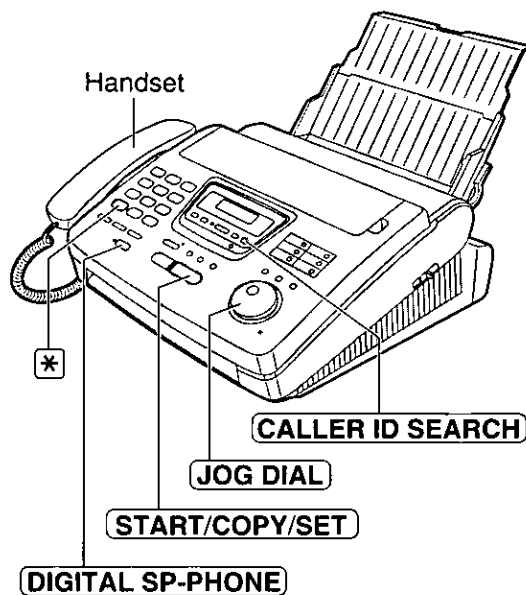

Telephone

To edit 10 digit telephone numbers into one of 4 patterns

Press ***** in step 2 to select a pattern.

Each time you press *****, the number is arranged into one of 4 different patterns.

- a:

Telephone number

- b: 1-

Area code

 -

Telephone number

- c: 1-

Telephone number

- d:

Area code

 -

Telephone number

Storing a telephone number in the One-Touch Dial and JOG DIAL directory from the Caller ID list

You can store a name and telephone number in the One-Touch Dial and JOG DIAL directory from the Caller ID list.

Important:

- This feature is not available in the following cases.
 - The telephone number includes data other than numbers (ie., * or #).
 - The telephone number information was not received.

1 Press **CALLER ID SEARCH**.

Example:

↓

Display:

2 Rotate **JOG DIAL** until the name you want to store is displayed.

Example:

3 Press **DIRECTORY PROGRAM**.

↓

4 a: To store in the One-Touch Dial memory:
For stations 1–5, press one of the One-Touch Dial keys.

Example:

Press **START/COPY/SET**.

For stations 6–10, press **LOWER**, then press one of the One-Touch Dial keys.

Example:

Press **START/COPY/SET**.

- A new entry will overwrite any previous information.
- If you are using One-Touch Dial key 1 as the BROADCAST key (see page 66), One-Touch Dial key 1 cannot be used for this feature.
- When storing, you can only store a name up to 10 characters long. To edit the name and number, see the instructions on pages 38 and 39.

b: To store in the JOG DIAL directory:

Rotate **JOG DIAL**.

Example:

Press **START/COPY/SET**.

- If the directory is full, a name and number cannot be stored.
- When storing, you can only store a name up to 10 characters long. To edit the name and number, see the instructions on page 42.

5 Press **START/COPY/SET**.

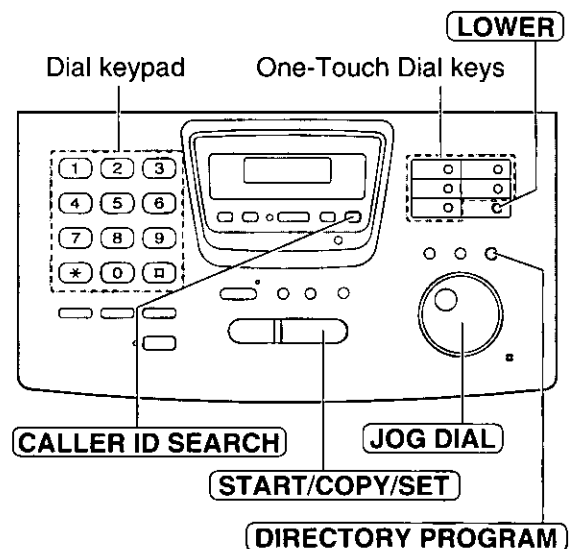

Note:

- You cannot store caller information in the One-Touch Dial and JOG DIAL directory if a telephone number is not displayed.

Erasing a name/number from the Caller ID list

You can erase some or all of the entries in the Caller ID list.

Erasing a specific caller's information

- 1** Press **CALLER ID SEARCH**.
Example:

2 NEW CALLS

↓

Display:

USE JOG-DIAL

- 2** Rotate **JOG DIAL** until the desired name is displayed.

WENDY ROBERTS

- 3** Press **ERASE**.
 - The caller's information is erased.

DELETED

↓

ALLAN STONE

• To erase other caller's information, repeat steps 2 to 3.

- 4** Press **STOP** to exit the program.

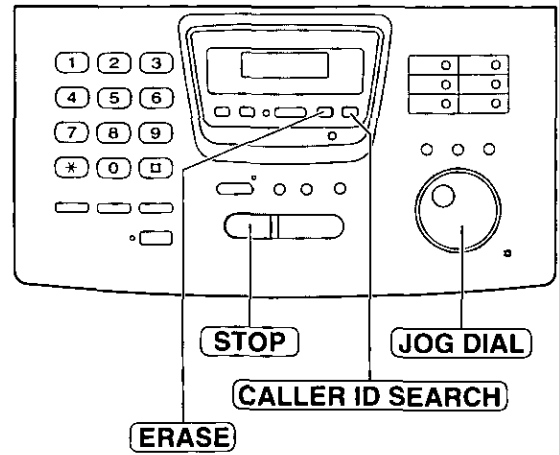

Telephone

Caller ID

Erasing all callers' information

- 1 Press **MENU** three times.
Display: **3.CALLER SET UP**
- 2 Press **START/COPY/SET**.
PRESS [▼ ▲] & [SET]
- 3 Press **▼** or **▲** until the following message is displayed.
CALL LIST ERASE
- 4 Press **START/COPY/SET**.
ALL ERASE OK?
 - o If you do not want to erase the information, press **STOP**.
- 5 Press **START/COPY/SET**.
ERASE COMPLETED
- 6 Press **STOP** to exit the program.

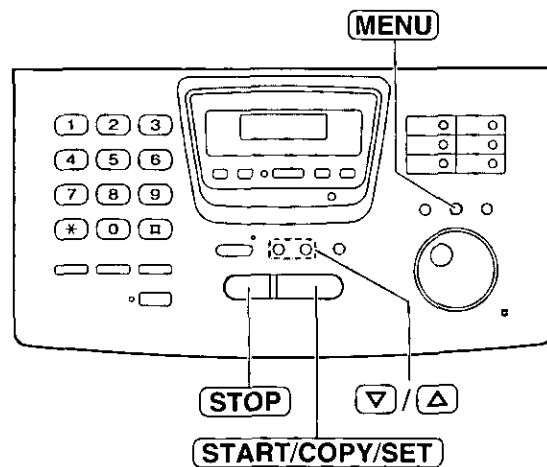

Storing your area code

When this feature is set, the caller's telephone number is displayed without the area code when a call is received from the same area. If the call is received from outside your area, the telephone number will be displayed with "1" at the beginning.

- 1 Press **MENU** three times.
Display: **3. CALLER SET UP**
- 2 Press **START/COPY/SET**.
PRESS [▼▲] & [SET]
- 3 Press **▼** or **▲** until the following message is displayed.
AREA CODE
- 4 Press **START/COPY/SET**.
CODE=
- 5 Enter your area code using 3 digits with the dial keypad.
- 6 Press **START/COPY/SET**.
REGISTERED
- 7 Press **STOP** to exit the program.

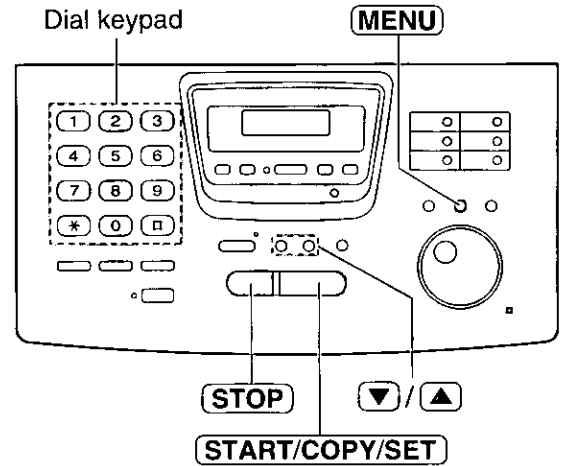

Telephone

To erase the area code

- Press **STOP** when your area code is displayed in step 4. Then press **START/COPY/SET**.
To exit the program, press **STOP**.

Caller ID

Automatic Caller ID list

This feature prints a Caller ID list automatically after every 35 new calls.

After printing, only the oldest caller information will be erased when a new one is received.

When this feature is turned off, the unit will store the records of caller information, but will not print the Caller ID list automatically.

- 1 Press **MENU**.
Display: 1.SYSTEM SET UP
- 2 Press **□**, then **2** **6**.
AUTO CALL. LIST
- 3 Press **START/COPY/SET**.
MODE=ON ▽ ▲
- 4 Press **▽** or **▲** to select the desired setting.
• If this feature is not required, select "OFF".
- 5 Press **START/COPY/SET**.
SETUP ITEM []
- 6 Press **MENU**.

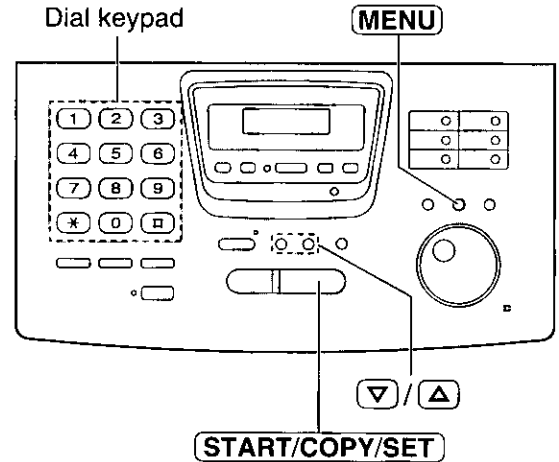

Sample of a Caller ID list

CALLER ID LIST				
Jan. 04 1998 04:37PM				
[NEW]				
NO.	NAME	TELEPHONE NUMBER	TIME OF CALL	ANSWER
01	WENDY ROBERTS	123-345-3809	Jan. 04 02:35PM	FAX
02	ALLAN STONE	456-103-2238	Jan. 03 08:35AM	TAD
[OLD]				
NO.	NAME	TELEPHONE NUMBER	TIME OF CALL	ANSWER
01	MIKE TIMAR	789-345-1029	Jan. 01 02:35PM	TEL

• The NAME/TELEPHONE NUMBER/TIME OF CALL information are received through a Caller ID service (see page 45).

• ANSWER: How the call was received by the unit.

— FAX: Facsimile

— TAD: Telephone answering device

— TEL: Telephone

When nothing is shown, there was no response.

Talking to the caller after fax transmission or reception

You can have a conversation during the same call after the fax message is completed. This will save the added expense and time of making another call.

This feature only works when the other party's fax machine is equipped with a voice contact feature.

Initiating voice contact

- 1 Press **DIGITAL SP-PHONE** while transmitting or receiving documents.

Display: VOICE STANDBY

- Your unit will call the other party with a distinctive ring.
- When the other party answers, your unit will emit a distinctive ring.

- 2 Press **DIGITAL SP-PHONE** or lift the handset to start talking.

Note:

- If you initiate voice contact during transmission, the unit will call you with a distinctive ring after all of the documents have been transmitted.
- If you initiate voice contact during reception, the unit will call you with a distinctive ring after the current page of the document is received.

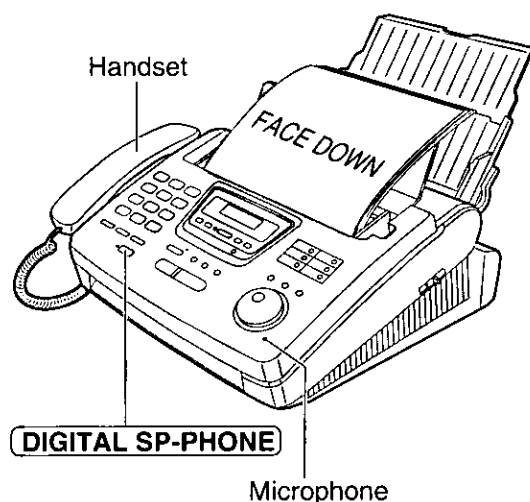

Telephone

Receiving a request for voice contact

- 1 If the other party initiates voice contact, your unit will sound a distinctive ring and the following will be displayed.

Display: PLEASE PICK UP

- 2 Press **DIGITAL SP-PHONE** or lift the handset within 10 seconds of the distinctive ring to start talking.

Note:

- If you do not answer within 10 seconds of the distinctive ring:
 - if in the TAD/FAX mode, your unit will play a greeting message and record an incoming voice message.
 - if in the FAX ONLY, TEL or TEL/FAX mode, the line will be disconnected.

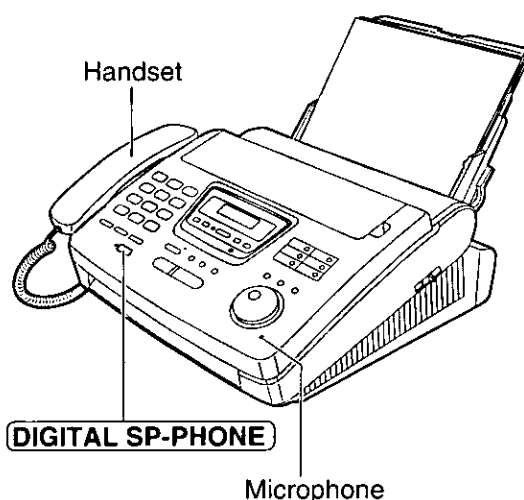

Sending Faxes

Sending a fax manually

- 1 Open the document feeder tray.
- 2 Adjust the width of the document guides to the size of the document.
- 3 Insert the document (up to 15 pages) **FACE DOWN** until a single beep is heard and the unit grabs the document.

Display: STANDARD

- 4 If necessary, press **RESOLUTION** repeatedly to select the desired setting (see the bottom of this page).

- 5 Press **DIGITAL SP-PHONE** or lift the handset.

TEL=

- 6 Dial the fax number.

Example: TEL=5678901

- 7 **When a fax tone is heard:**
Press **START/COPY/SET**, and hang up the handset if using it.

OR

When the other party answers your call:

Ask them to press their start button. When a fax tone is heard, press your **START/COPY/SET** and hang up the handset if using it.

CONNECTING.....

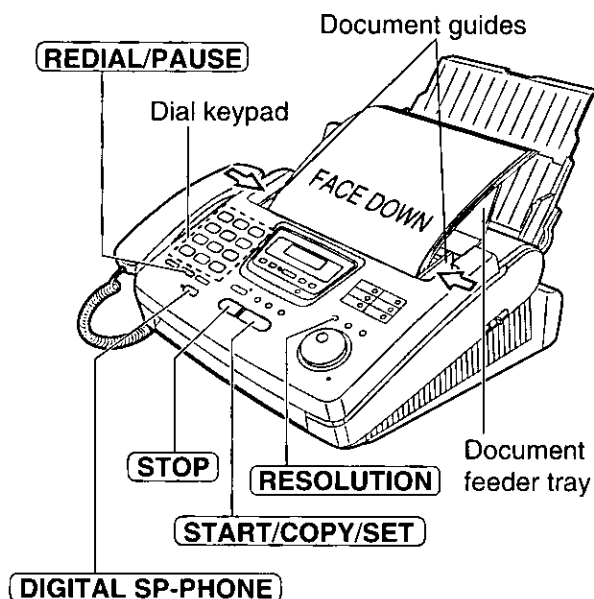

Note:

- o If you cannot send a fax, confirm the problem by printing a journal report (see page 121) and try to solve the problem (see page 108).

To feed more than 15 pages at a time

Insert the first 15 pages of the document. Add the extra pages (up to 15) before the last page is fed into the unit.

To redial the last number

Press **REDIAL/PAUSE**.

- o If the line is busy, the unit will automatically redial the number up to 5 times.
- o During redial, the following will be displayed.

Display: WAITING REDIAL

To stop transmission

Press **STOP**.

To eject the document, press **STOP** again.

To select the resolution

Select the desired resolution according to the type of document.

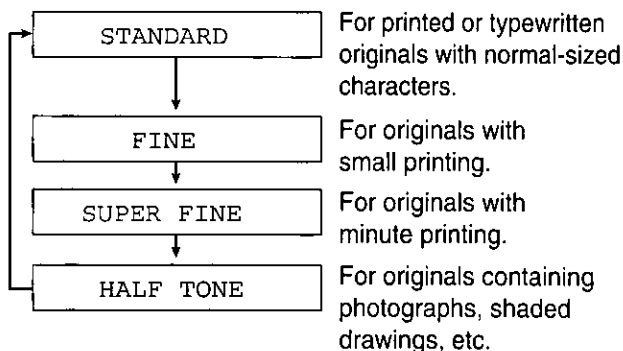

- o Using the fine, super fine or half tone setting will increase the transmission time.
- o If the resolution setting is changed during feeding, it will be effective from the next sheet.
- o The super fine resolution only works with other compatible fax machines.

Sending a fax using the One-Touch Dial

Before using this feature, program the desired names and telephone numbers into the One-Touch Dial (see page 38).

- 1** Open the document feeder tray.
- 2** Adjust the width of the document guides to the size of the document.
- 3** Insert the document (up to 15 pages) **FACE DOWN** until a single beep is heard and the unit grabs the document.

Display: STANDARD

- 4** If necessary, press **RESOLUTION** repeatedly to select the desired setting (see the bottom of page 54).

- 5** **For stations 1–5**
Press the desired One-Touch Dial key.
For stations 6–10
Press **LOWER**, then press the desired One-Touch Dial key.

Example: FAX=<John>
↓
CONNECTING.....

• The unit will start transmission.

Helpful hints:

- To confirm the items stored in the One-Touch Dial, print a telephone number list (see page 121).
- You can use the JOG DIAL directory to select the station name instead of using the One-Touch Dial keys. Rotate **JOG DIAL** until the desired name is displayed, then press **START/COPY/SET**.
- The connecting tone will be heard during dialing to tell you the status of the other party's machine (see page 69).

Note:

- If your fax does not transmit, press **DIGITAL SP-PHONE** and then repeat step 5. Verify that the number dialed is answered by the other party's fax machine.

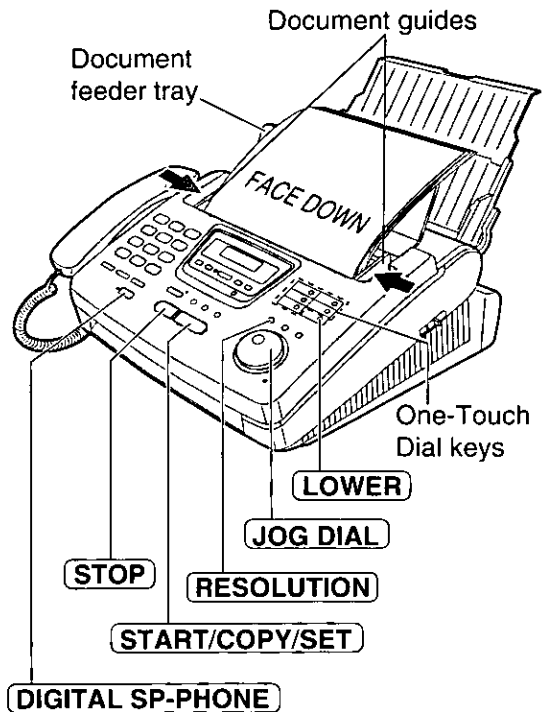

Fax auto redial

If the line is busy or there is no answer, the unit will automatically redial the number up to 5 times.

- This feature is also available for;
 - sending faxes using the JOG DIAL directory (page 56), and
 - delayed transmission (page 64).
- During redial, the following will be displayed.

Display: WAITING REDIAL

- To cancel redialing, press **STOP**.

Sending Faxes

Sending a fax using the JOG DIAL directory

Before using this feature, program the desired names and telephone numbers into the directory (see page 41).

- 1 Open the document feeder tray.
- 2 Adjust the width of the document guides to the size of the document.
- 3 Insert the document (up to 15 pages) FACE DOWN until a single beep is heard and the unit grabs the document.

Display:

- 4 If necessary, press **RESOLUTION** repeatedly to select the desired setting (see the bottom of page 54).

- 5 Rotate **JOG DIAL** until the desired name is displayed.

Example:

- To confirm the number, press **NAME/TEL NO.**

- 6 Press **START/COPY/SET**.

Example:



- The unit will start transmission.

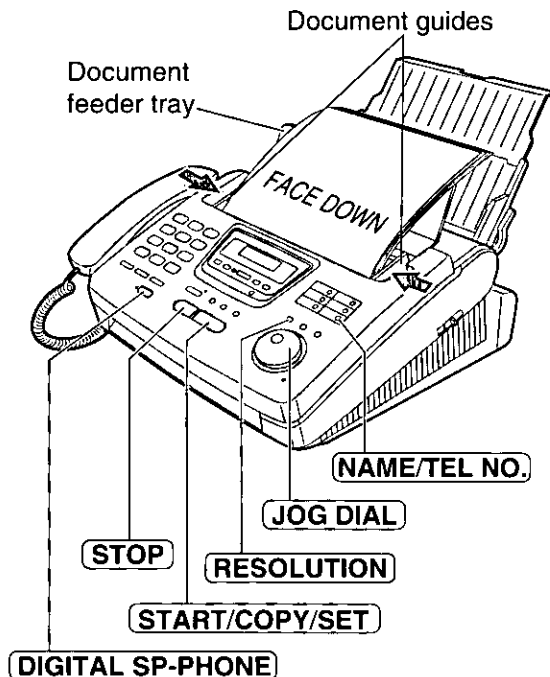

Helpful hints:

- To confirm the items stored in the directory, print a telephone number list (see page 121).
- The connecting tone will be heard during dialing to tell you the status of the other party's machine (see page 69).

Note:

- If the desired name has not been stored, press **STOP** and dial the number manually.
- For further details about using the JOG DIAL, see page 44.
- If your fax does not transmit, press **DIGITAL SP-PHONE** and then repeat steps 5 and 6. Verify that the number dialed is answered by the other party's fax machine.

IQ-FAX

This feature can only be used by those who apply to the FaxSav service.

IQ-FAX is intelligent faxing which allows you to send faxes via the internet by using the IQ-FAX button. Behind the IQ-FAX button is the FaxSav Global Fax Network which manages the delivery of your fax to any fax machine in the world. It routes your fax via the best and most time efficient route and will automatically resend your fax for you, if the receiving fax machine is unavailable.

This "fax-only" network has the added advantage of cost efficiency due to the internet being integrated into the network. Every fax is secure since the FaxSav network utilizes the highest encryption legally allowed, ensuring that your documents stay secure. You get the benefits of carefree faxing with savings associated with the use of the internet. It is simple, quick, and secure.

For more information, contact FaxSav at 1-888-332-9728. This number is pre-programmed in the JOG DIAL directory (see page 41).

How your fax is sent to the other party's fax machine

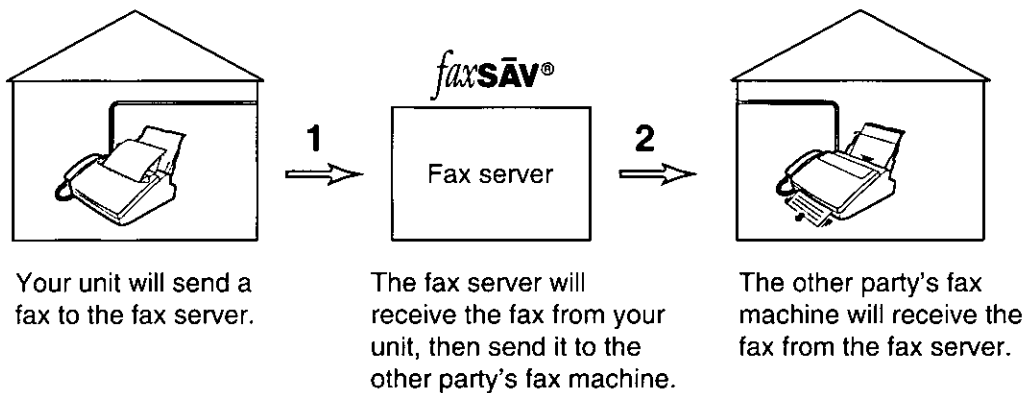

Your unit will send a fax to the fax server.

The fax server will receive the fax from your unit, then send it to the other party's fax machine.

The other party's fax machine will receive the fax from the fax server.

- 1 If any transmission errors occur between your unit and the fax server, your unit will automatically redial the fax server up to 2 times.
- 2 If any transmission errors occur between the fax server and the other party's fax machine, the fax server will automatically redial the other party's fax machine up to 4 times. If your fax is still not transmitted after 4 attempts, the fax server will fax a Non-Delivery Notice to you. In this case, there is no charge. Set your unit to receive a fax.

How to apply for the FaxSav Internet service for your unit

- 1 Fill out the attached application form and fax it to 1-800-909-6649.
 - The FaxSav company will send you a welcome fax after they have activated your account.
 - There is no application or monthly fee. You pay only for the faxes you send.
- 2 To enable the IQ-FAX function from your fax machine, set feature setting #75 to ON (see page 58).

Sending Faxes

Turning on the IQ-FAX function

Before programming, confirm that your application has been processed by FaxSav.

- 1** Press **MENU**.
Display: 1. SYSTEM SET UP
- 2** Press **7 5**, then **7 5**.
IQ-FAX
- 3** Press **START/COPY/SET**.
MODE=OFF ▼▲
- 4** Press ▼ or ▲ to select "ON".
MODE=ON ▼▲
 - If this feature is not required, select "OFF".
- 5** Press **START/COPY/SET**.
SETUP ITEM []
- 6** Press **MENU**.

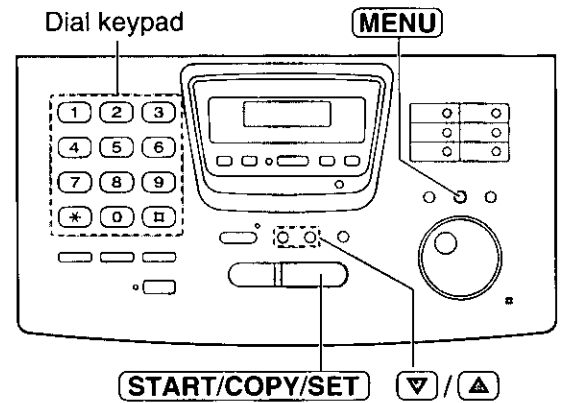

Sending a fax using the Internet

- 1 Open the document feeder tray.
- 2 Adjust the width of the document guides to the size of the document.
- 3 Insert the document (up to 15 pages) **FACE DOWN** until a single beep is heard and the unit grabs the document.

Display: STANDARD

- 4 If necessary, press **RESOLUTION** repeatedly to select the desired setting (see the bottom of page 54).

- 5 Press **IQ-FAX**.

IQFAX TO WHERE?

- 6 Enter the fax number using the dial keypad, One-Touch Dial or **JOG DIAL**.

- You can use the **BROADCAST** key (see pages 66 and 67).

FAX=

- 7 Press **START/COPY/SET**.

TRYING IQ-FAX



CONNECTING.....



SENDING P1



SENT TO SERVER

- If the number you dialed is out of the FaxSav network service area, the unit will show the following messages and send the fax directly over the telephone line.

OUT OF NETWORK



SENDING NORMAL

- If "OUT OF NETWORK" is displayed when sending a fax long distance or internationally using IQ-FAX, then contact FaxSav at 1-888-332-9728.

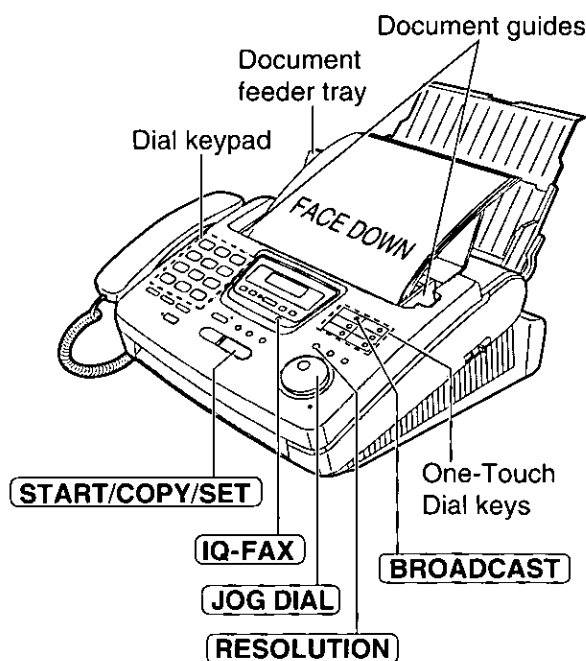

If you cannot send a fax

Contact FaxSav at 1-888-332-9728.

The FaxSav customer service center may send you a program update. While receiving this update, you will not be able to operate the unit and the following message will be displayed for about 3 minutes. During this time, you also will not be able to operate extension telephones, if they are connected.

Display: LOADING IQ-DATA

If a loading error occurs, the unit will display the following message.

LOADING ERROR

In this case, contact FaxSav at 1-888-332-9728.

Sending Faxes

Documents you can send

Minimum size

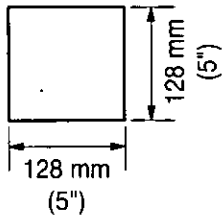

Maximum size

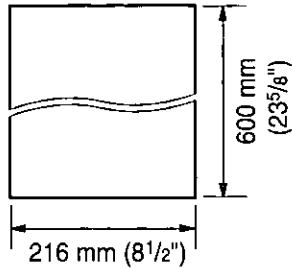

Effective scanning area

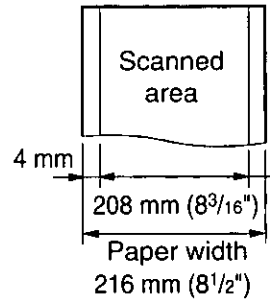

Document weight

Single sheet:
45 g/m² to 90 g/m²
(12 lb. to 24 lb.)

Multiple sheets:
60 g/m² to 75 g/m²
(16 lb. to 20 lb.)

Note:

- Remove clips, staples or other similar fastening objects.
- Check that ink, paste or correction fluid has dried.
- Do not send the following types of documents. Use copies for fax transmission.
 - Chemically treated paper such as carbon or carbonless duplicating paper
 - Electrostatically charged paper
 - Heavily curled, creased or torn paper
 - Paper with a coated surface
 - Paper with a faint image
 - Paper with printing on the opposite side that can be seen through the front (e.g. newspaper)

Sending faxes by following the voice guide

You can send the documents by following the voice guide. After transmission, the voice guide will turn off automatically.

1 Press **MENU** four times.
Display: 4 . SEND GUIDE

2 Press **HELP**.

Voice guide:

To transmit, insert the document face down until you hear the beep.

3 Insert the document FACE DOWN until a beep tone is heard.

Voice guide:

Press the speaker phone button, then dial the phone number. When the fax tone is heard, press the start button.

4 Press **DIGITAL SP-PHONE**.

5 Dial the fax number.

6 When a fax tone is heard, press **START/COPY/SET**.

Voice guide:

Start transmission.

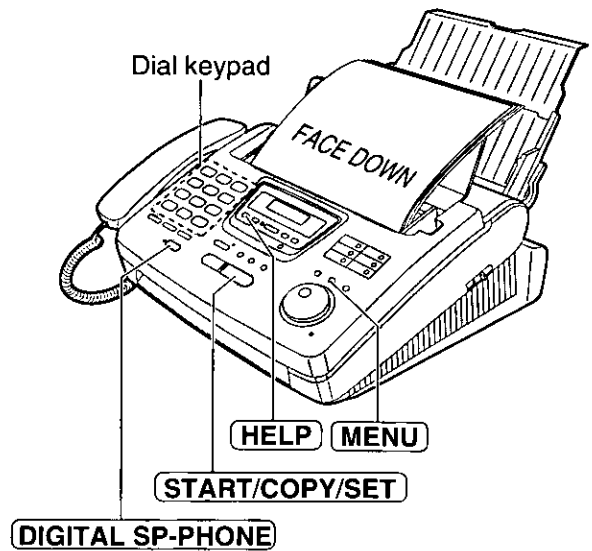

Note:

- You can lift the handset instead of pressing **DIGITAL SP-PHONE** in step 4.

Sending Faxes

Sending report for confirmation

The sending report will provide you with a printed record of the fax transmission result. One of the following choices is available.

ERROR: The sending report will print out only when fax transmission fails (pre-selected setting).

ON: The sending report will always print out, indicating whether fax transmission is successful or not.

OFF: The sending report will not print.

- 1 Press **MENU**.
Display: 1.SYSTEM SET UP
- 2 Press **□**, then **0 4**.
SENDING REPORT
- 3 Press **START/COPY/SET**.
MODE=ERROR ▼▲
- 4 Press ▼ or ▲ to select the desired setting.
- 5 Press **START/COPY/SET**.
SETUP ITEM []
- 6 Press **MENU**.

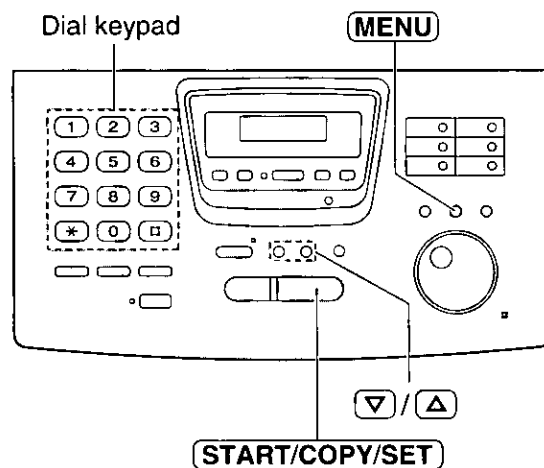

Sample of a sending report

SENDING REPORT							
Jan. 20 1998 01:19PM							
NO.	OTHER FACSIMILE	START TIME	USAGE TIME	MODE	PAGES	RESULT	*CODE
01	2345678	Jan. 20 01:18PM	00'51	SND	00	COMMUNICATION ERROR	(43)

SND: Sent directly.
 IQ-FAX: Sent to the fax server.

Communication message
 (See page 108.)

Error code
 (for service personnel use only)

Note:

- If your fax is not transmitted to the other party's fax machine using the FaxSav network, the FaxSav network will send a Non-Delivery Notice to your unit.

Automatic journal report

This feature prints a journal report automatically after every 35 new fax communications. After printing, only the oldest communication result will be erased when a new communication occurs. When this feature is deactivated, the unit will store the records of the fax communications, but will not print the journal report automatically.

- 1 Press **MENU**.
 Display: 1. SYSTEM SET UP
- 2 Press **☐**, then **2 2**.
 AUTO JOURNAL
- 3 Press **START/COPY/SET**.
 MODE=ON ▼▲
- 4 Press ▼ or ▲ to select the desired setting.
 • If this feature is not required, select "OFF".
- 5 Press **START/COPY/SET**.
 SETUP ITEM []
- 6 Press **MENU**.

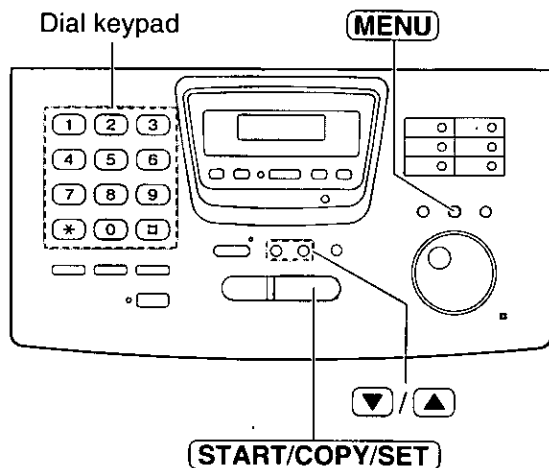

Fax/Copy

Sample of a journal report

JOURNAL							
Jan. 25 1998 05:22PM							
NO.	OTHER FACSIMILE	START TIME	USAGE TIME	MODE	PAGES	RESULT	*CODE
01	3332222	Jan. 21 02:14PM	00'45	SND	01	OK	
02	9998765	Jan. 21 03:17PM	00'58	IQ-FAX	02	OK	
03	John	Jan. 21 05:18PM	00'48	RCV	01	OK	
04	555556677	Jan. 22 10:35AM	02'45	SND	03	COMMUNICATION ERROR	(43)
05			02'50	SND	05	OK	
06				RCV	03	OK	

SND: Sent directly.
 IQ-FAX: Sent to the fax server.
 RCV: Received directly.

Communication message (See page 108.)

Error code (for service personnel use only)

Note:

- If your fax is not transmitted to the other party's fax machine using the FaxSav network, the FaxSav network will send a Non-Delivery Notice to your unit.

Sending Faxes

Delayed transmission (sending a fax at a specified time)

Using a built-in clock, this unit can send documents automatically at a specified time. This allows you to take advantage of low-cost calling hours offered by your telephone company. The delayed transmission can be reserved to take place up to 24 hours in advance.

1 Insert the document FACE DOWN.
Display: STANDARD

2 Press **MENU**.
1.SYSTEM SET UP

3 Press **□**, then **2 5**.
DELAYED SEND

4 Press **START/COPY/SET**.
MODE=OFF ▽△

5 Press **▽** or **△** to select "ON".
MODE=ON ▽△

6 Press **START/COPY/SET**.
FAX=

7 Enter the fax number using the dial keypad, One-Touch Dial or **JOG DIAL**.

8 Press **START/COPY/SET**.
TIME=12:00AM

9 Enter the transmission start time.
Example (using the dial keypad): 11:30PM
Press **1 1 3 0**, then press ***** to select "PM".
TIME=11:30PM

o To select "AM", press ***** until "AM" is displayed.

10 Press **START/COPY/SET**.
SETUP ITEM []

11 Press **MENU**.
SEND AT 11:30PM

o When the programmed time arrives, the unit will automatically start transmission.

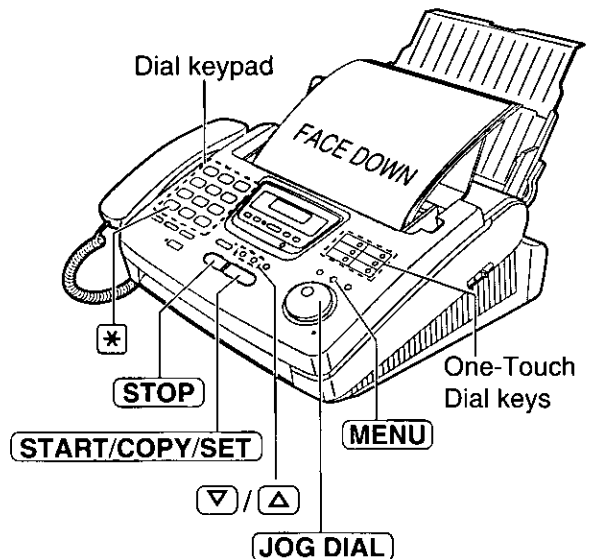

Note:

- o You can receive, transmit and copy documents while delayed transmission is set.

To cancel the delayed transmission setting

1. Press **STOP** while the unit is idle.

Display: SEND CANCELED?
↓
YES: PRESS SET

2. Press **START/COPY/SET**.

From memory

The unit is able to scan and store documents into memory, and then transmit the stored documents. The memory capacity is approx. 25 pages based on the CCITT No. 1 test chart in standard resolution. For the CCITT No. 1 test chart, see page 128.

Setting memory transmission

- 1 Press **MENU**.
 Display: 1.SYSTEM SET UP
- 2 Press **□**, then **1 5**.
SEND BY MEMORY
- 3 Press **START/COPY/SET**.
MODE=OFF ▼▲
- 4 Press ▼ or ▲ to select "ON".
MODE=ON ▼▲
 - If this feature is not required, select "OFF".
- 5 Press **START/COPY/SET**.
SETUP ITEM []
- 6 Press **MENU**.

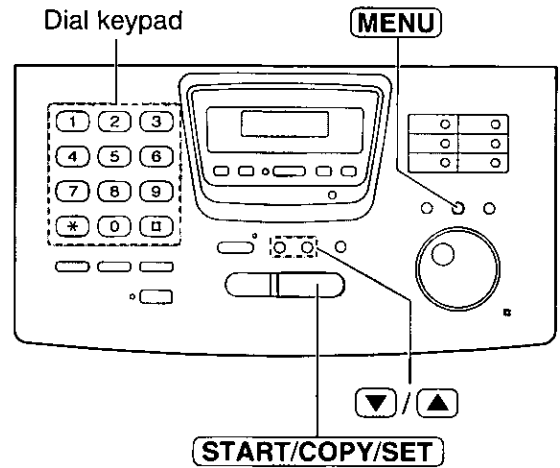

Fax/Copy

Transmitting documents from memory

- 1 Insert the document FACE DOWN.
- 2 Enter the fax number using the dial keypad, One-Touch Dial or **JOG DIAL**.
- 3 When using the dial keypad or **JOG DIAL**, press **START/COPY/SET**.
 - The document will be fed into the unit and scanned into memory. After storing all of the pages, the unit will transmit the documents.
 - The amount of memory used will be shown as a percentage on the display.

Display: PAGES=01 05
 Amount of memory used

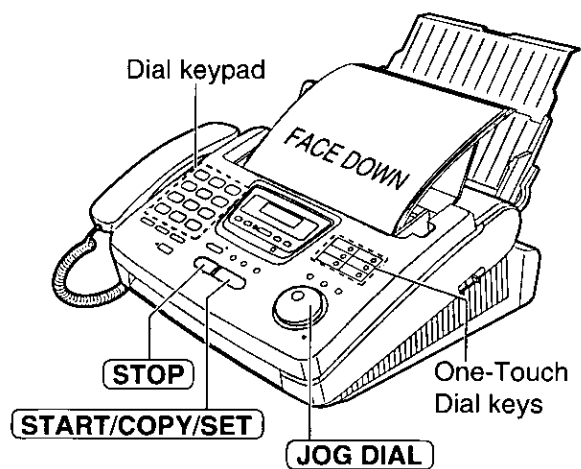

Note:

- The stored documents will be automatically erased after transmission.
- To cancel the memory transmission, press **STOP** during or after scanning the document.
- If you select the fine, super fine or half tone resolution, the number of documents that can be sent will decrease.
- If the stored pages exceed the memory capacity, the transmission will be canceled.

Sending Faxes

Multiple stations

This feature is useful when you send the same documents to selected parties whose telephone numbers are stored in the One-Touch Dial and JOG DIAL directory frequently. You must program the desired parties into the BROADCAST key (One-Touch Dial key 1) or as the broadcast key.

Important:

- Before programming, make sure that the desired telephone numbers have been stored into the One-Touch Dial or JOG DIAL directory.
- The BROADCAST key can be used as One-Touch Dial key 1 or as the broadcast key.

Programming the BROADCAST key with telephone numbers

1 Press **DIRECTORY PROGRAM**.

Display: **PRESS STATION**
↓
OR USE JOG-DIAL

2 Press **BROADCAST**.

DIAL MODE ▽ ▲

3 Press ▽ or ▲ to select "BROADCAST".

BROADCAST ▽ ▲

4 Press **START/COPY/SET**.

DIR= [000]

5 Enter the stations.

a: Using the One-Touch Dial:

For stations 2–5, press the preset One-Touch Dial key.

For stations 6–10, press **LOWER**, then press the preset One-Touch Dial key.

Example: **DIR=Luke** [001]

b: Using the JOG DIAL directory:

Rotate **JOG DIAL** until the desired name is displayed (up to 100 stations for the KX-FP270, 60 stations for the KX-FP265).

Example: **John** [001]

Press **START/COPY/SET**.

John [002]

- To enter other stations, repeat this step (up to 109 stations for the KX-FP270, 69 stations for the KX-FP265).

6 Press **START/COPY/SET** after entering all of the desired stations.

7 Press **DIRECTORY PROGRAM** to exit the program.

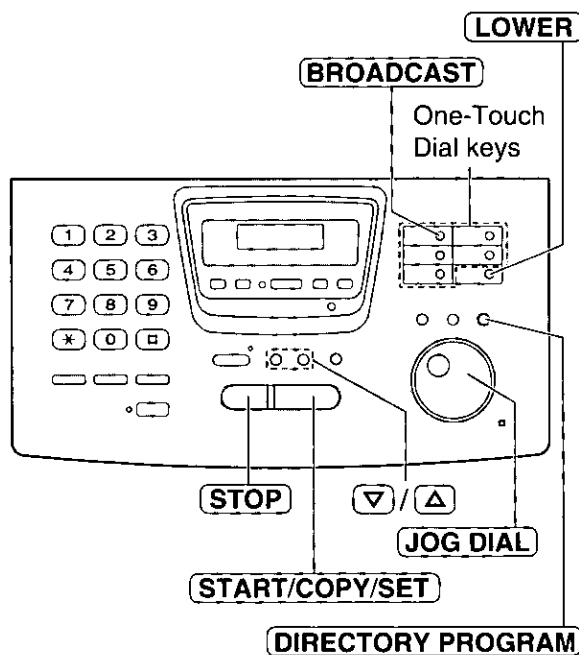

Note:

- If you make a mistake while programming, press **STOP**, then make the correction.
- Confirm the stored numbers by printing a telephone number list (see page 121).

Using the BROADCAST key

The documents will be scanned and stored into memory when using the BROADCAST key. After transmission, the stored documents will be erased automatically.

The memory capacity is approx. 25 pages based on the CCITT No. 1 test chart in standard resolution. For the CCITT No. 1 test chart, see page 128.

- 1** Insert the document FACE DOWN.
- 2** Press **BROADCAST**.
 - The documents will be fed into the unit and scanned into memory. Then the unit will transmit the data to each station, calling each number sequentially.

Note:

- If you select the fine, super fine or half tone resolution, the number of pages that the unit can transmit will decrease.
- If one of the stations is busy or does not answer, the station will be skipped. All skipped stations will be redialed up to 5 times after all of the other stations have been called.

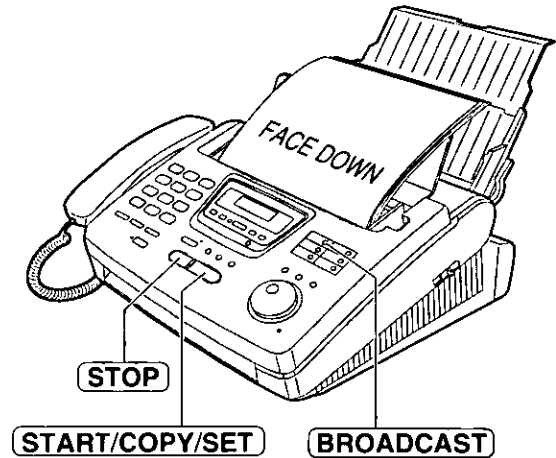

Fax/Copy

To cancel the broadcast setting

1. Press **STOP** while the unit displays "BROADCASTING".

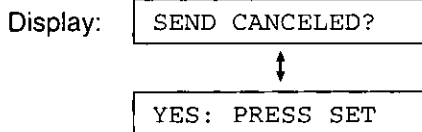

2. Press **START/COPY/SET**.

Broadcast report

After all of the transmissions have been completed, the unit will automatically print the following report.

Sample of a broadcast report:

BROADCAST REPORT							(1/1)
							Jan. 10 1998 03:36PM
NO.	OTHER FACSIMILE	START TIME	USAGE TIME	PAGES (IQ-FAX)		RESULT	
001	Mike	Jan. 10 03:31PM	01'10	02	*	OK	
002	Peter	Jan. 10 03:33PM	01'08	02	*	OK	
003	Sam	Jan. 10 03:34PM	01'09	02	*	OK	
004	Kim	Jan. 10 03:35PM	01'10	02	*	OK	
TOTAL			004'37	008 (008)			

Total number of pages sent to the fax server.

The "*" mark in this column shows the fax has been sent to the fax server.

Sending Faxes

Overseas

You may experience difficulty when transmitting documents overseas. This feature makes sending documents easier as the transmission speed is slowed down. Before starting transmission, follow the steps below.

- 1 Press **MENU**.
Display: 1.SYSTEM SET UP
- 2 Press **□**, then **2** **3**.
OVERSEAS MODE
- 3 Press **START/COPY/SET**.
MODE=OFF ▼▲
- 4 Press ▼ or ▲ to select "ON".
MODE=ON ▼▲
 - If this feature is not required, select "OFF".
- 5 Press **START/COPY/SET**.
SETUP ITEM []
- 6 Press **MENU**.

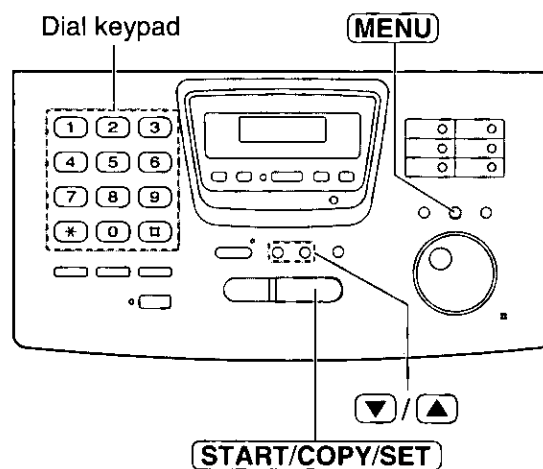

Note:

- After transmission, this feature will turn off automatically.
- This feature is not available for transmission using the BROADCAST key.
- A slower transmission speed will lengthen the call duration. Therefore, the calling charge may be higher.

Connecting tone

This feature allows you to hear connecting tones, such as a fax tone, ring back tone or busy tone for several seconds when you send a fax using the One-Touch Dial or JOG DIAL directory. This will tell you the status of the other party's machine.

If you hear a:

- Fax tone: The other party's machine is ready for reception.
- Ring back tone: If this tone continues, the other party's machine may not be a facsimile or ran out of paper. Check with the other party.
- Busy tone: The other party's machine is busy. Let the unit continue redialing or press **STOP** and try again later.

If this feature is not required, turn it off.

- 1 Press **MENU**.
Display: 1.SYSTEM SET UP
- 2 Press **□**, then **7 6**.
CONNECTING TONE
- 3 Press **START/COPY/SET**.
MODE=ON ▼▲
- 4 Press ▼ or ▲ to select the desired setting.
● If this feature is not required, select "OFF".
- 5 Press **START/COPY/SET**.
SETUP ITEM []
- 6 Press **MENU**.

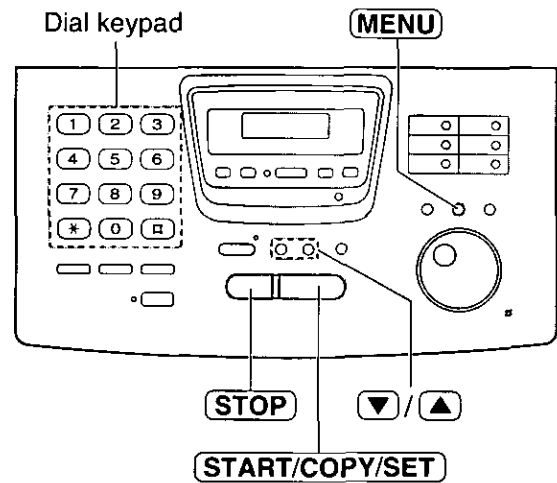

Note:

- The connecting tone volume cannot be adjusted.

Receiving Faxes

Setting the unit to receive calls

Option A

Option B

How you want the unit to receive faxes

To receive voice and fax calls automatically.

You have a separate telephone line just for fax calls.



Voice/Fax call

Fax call

TAD/FAX mode

(Telephone Answering Device/Facsimile mode)
(See page 89.)

PRE-SELECTED SETTING
AUTO ANSWER is ON.

FAX ONLY mode

(See page 73.)

AUTO ANSWER is ON.

You have to set this.

AUTO ANSWER
TAD/FAX ON

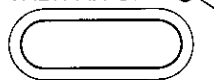

AUTO ANSWER light

o When the AUTO ANSWER light is on, AUTO ANSWER is on.

To turn the AUTO ANSWER light on, press **AUTO ANSWER**.

This is how the unit will operate.

When receiving voice calls:

The unit will activate the answering device and record voice messages.

When receiving fax calls:

The unit will activate the fax function to receive documents.

All incoming calls will be answered as faxes.

In the FAX ONLY mode, any call received on the line will be answered, and the unit will try to receive a fax - the display will show "CONNECTING.....". If it does not show "RECEIVING P1", then the incoming call was not a fax.

Option C

To answer all voice and fax calls yourself.



Voice/Fax call

TEL mode

(See page 72.)

AUTO ANSWER is OFF.

- When the AUTO ANSWER light is off, AUTO ANSWER is off.

To turn the AUTO ANSWER light off, press **AUTO ANSWER**.

When the unit rings, you must answer all calls.

- If you hear a fax calling tone (slow beep) or no sound is heard, press **START/COPY/SET**.

Option D

You have a Distinctive Ring service from the telephone company (this allows you to have up to 3 telephone numbers on the same line).

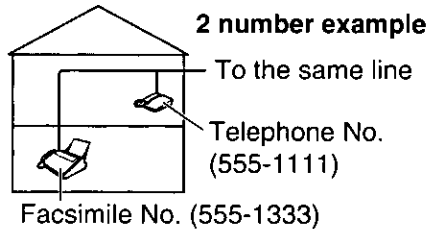

To activate the Distinctive Ring mode, select the same ring pattern assigned to the facsimile number in feature #31 (see pages 76 and 77).

- A:** Standard ring (one long ring)
- B:** Double ring (two short rings)
- C:** Triple ring (short-long-short rings)
- D:** Other triple ring (short-short-long rings)

The unit will automatically answer calls received at your facsimile number. If a call is received at the other telephone number, the unit will operate based on the receive mode you selected.

Other options

Voice mail

If you have a voice mail service from your telephone company, you also need to subscribe to a Distinctive Ring service. See pages 76 and 77.

With PC

If you have a computer attached to the same telephone line, see page 75.

TEL/FAX mode

If you are near the unit and want to use it to receive your voice calls yourself and fax calls automatically, see pages 78 to 81.

Remote activation

If you answer a telephone in another room and hear fax tones, you can activate the unit remotely by pressing *9. See page 82.

Receiving Faxes

TEL mode --- ---

(answering all calls manually)

Turn off the AUTO ANSWER mode by pressing **AUTO ANSWER** until the AUTO ANSWER light turns off.

- The display will show the following.

Display: TEL MODE

1 When the unit rings, press **DIGITAL SP-PHONE** or lift the handset to answer the call.

2 When:
— document reception is required,
— a fax calling tone (slow beep) is heard, or
— no sound is heard,
press **START/COPY/SET**.

CONNECTING

3 Hang up the handset, if using it.
• The unit will start reception.

Note:

- If you do not answer the call within 15 rings, the unit will temporarily activate the answering device. If you want to change to the TAD/FAX mode, enter the remote operation ID (see page 98) during the greeting message.

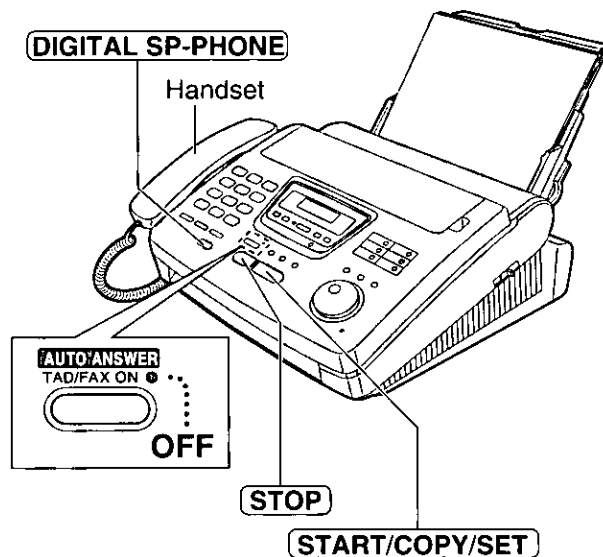

To stop receiving

Press **STOP**.

Friendly reception feature

When you answer a call and hear a fax calling tone (slow beep), the unit will automatically start receiving even if you do not press **START/COPY/SET**.

- If this feature is not required, set to "OFF" (see page 84).

Memory reception

When a printing problem is detected, the unit will temporarily store the received document into memory.

While documents are in memory, the unit will:
— display an error message and the following message alternately;

Display: FAX IN MEMORY

— alert you with slow beeps (Memory reception alert).

- Follow the instructions on pages 109 and 110 to solve the problem and print the stored document.
- For memory capacity, see page 128.

FAX ONLY mode

(all calls are received as faxes)

Changing the AUTO ANSWER setting to the FAX ONLY mode

- 1 Press **MENU**.
Display: 1.SYSTEM SET UP
- 2 Press **□**, then **7 7**.
AUTO ANSWER
- 3 Press **START/COPY/SET**.
MODE=TAD/FAX ▼▲
- 4 Press ▼ or ▲ to select "FAX ONLY".
MODE=FAX ONLY ▼▲
- 5 Press **START/COPY/SET**.
SETUP ITEM []
- 6 Press **MENU**.
- 7 If the AUTO ANSWER light is off, turn it on by pressing **AUTO ANSWER**.
FAX ONLY MODE

- The unit will automatically answer all calls and only receive fax documents.
- The number of rings before a call is answered can be changed (see page 74).

Note:

- This mode should not be used on a telephone line which is used for both voice and fax calls. When the unit answers the call, fax communication is attempted with the other fax machine even if someone is trying to call you.
- To change to the TAD/FAX or TEL/FAX mode, select "TAD/FAX" or "TEL/FAX" in step 4.

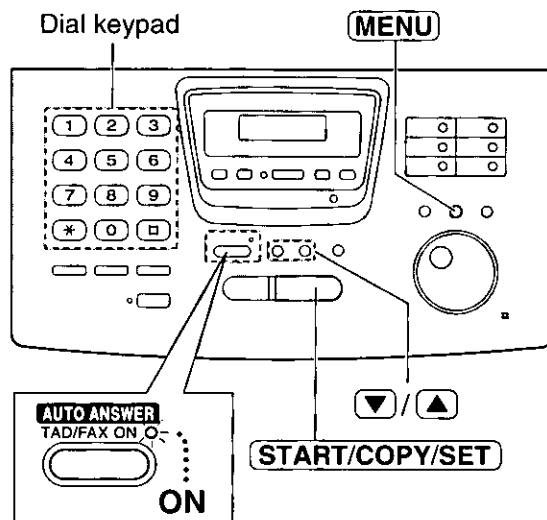

Receiving Faxes

Setting the ring count in the FAX ONLY mode

This setting determines the number of rings before the unit answers a call in the FAX ONLY mode. You can choose from 1 to 4 rings.

Helpful hints:

- o To answer a call before the unit does, increase the number of rings.
- o If you have difficulty receiving faxes, the other parties may have tried to send faxes before confirming if your unit answered or not. Decrease the number of rings.

1 Select "FAX ONLY" in step 4 of feature setting #77 (see page 73).

2 Press **MENU**.
Display: 1. SYSTEM SET UP

3 Press **06**, then **06**.
FAX RING COUNT

4 Press **START/COPY/SET**.
RING=2 ▽ ▲

5 Press **▽** or **▲** to select the desired number, or enter the number using the dial keypad.

6 Press **START/COPY/SET**.
SETUP ITEM []

7 Press **MENU**.

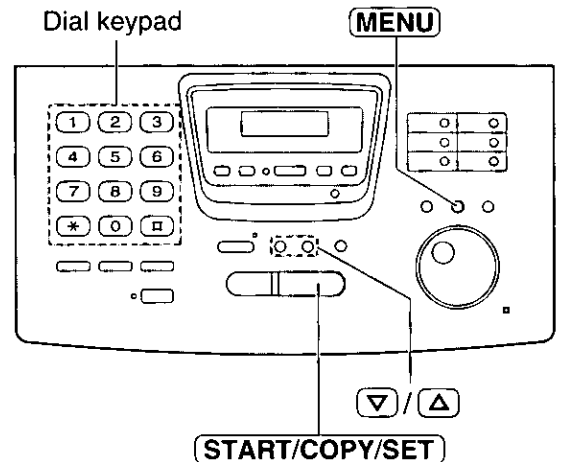

Note:

- o If you subscribe to a Caller ID service, set this ring count setting to 2 or more rings.

If you have a telephone line just for receiving faxes, we recommend the following setup.

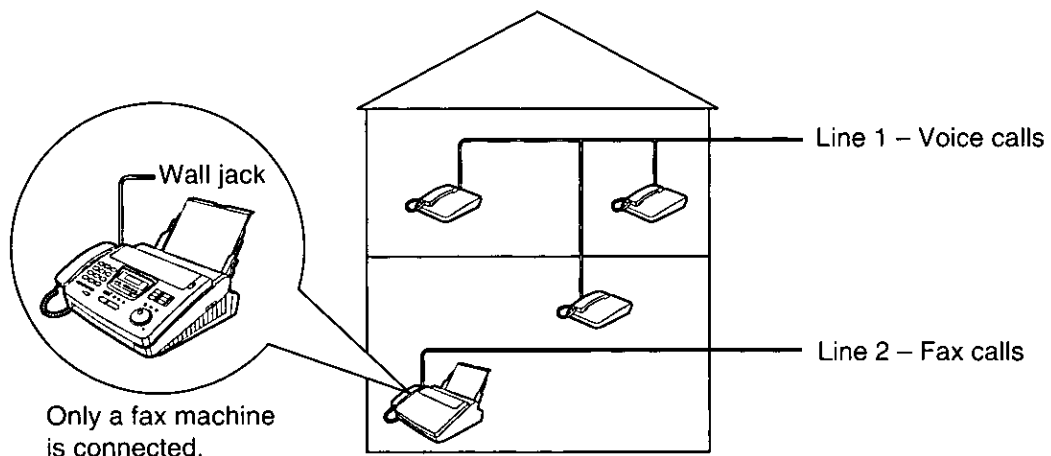

Example: A telephone line is used for voice calls and a separate telephone line for faxes. Therefore, two telephone lines are used. When someone is sending a fax, the fax machine will ring twice (see above).

Setting up with a computer

Always connect the fax machine directly to the wall jack.

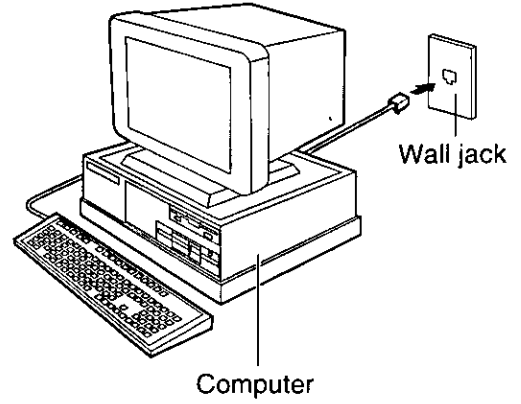
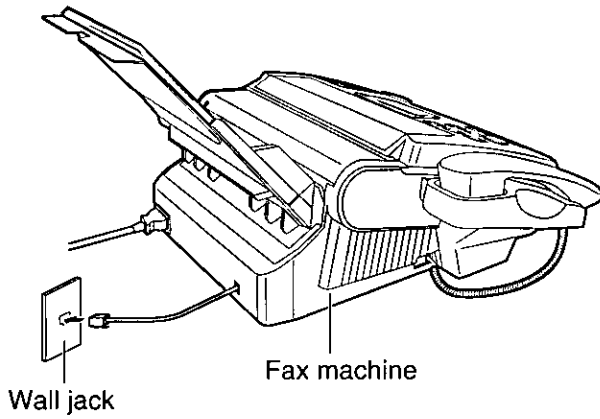

Note:

- Turn off the AUTO ANSWER mode on the fax machine.
- The device which has the shortest ring count will answer a call first.

Receiving Faxes

Distinctive Ring service --- --- (ring pattern detection feature)



This feature can only be used when you subscribe to a Distinctive Ring service from your telephone company. For more information on the availability of this service, contact your telephone company before activating this feature.

This feature will work irregardless of the AUTO ANSWER or receive mode settings.

What is a Distinctive Ring service?

A Distinctive Ring service will give you up to 3 telephone numbers on a single telephone line, each having a different ringing pattern.

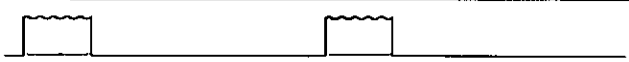
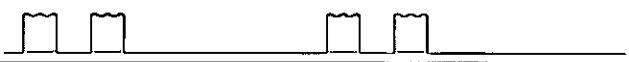
Ring patterns:

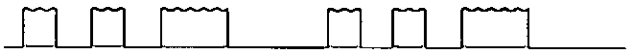
Standard ring (one long ring)	
Double ring (two short rings)	
Triple ring (short-long-short rings)	
Other triple ring (short-short-long rings)	

When you subscribe to a Distinctive Ring service, you can assign telephone numbers for personal numbers, business numbers, fax numbers, and so on.

When a call is received, you will know which number is being called by the ringing pattern.

Example:

Your telephone number	Ring pattern	Use
012 1234	Standard ring	Personal
012 5678	Double ring	Business
012 9876	Triple ring	Facsimile

To use one of the telephone numbers as a facsimile number

Program the ring pattern assigned to the facsimile number (see the next page).

When the unit detects a call matching the selected Distinctive Ring pattern, it will activate the fax function.

Setting the Distinctive Ring pattern assigned for faxes

Select the ring pattern of the facsimile number that is assigned by your telephone company.

- 1** Press **MENU**.
Display: 1. SYSTEM SET UP
- 2** Press **□**, then **3 1**.
RING DETECTION
- 3** Press **START/COPY/SET**.
MODE=OFF ▼▲
- 4** Press ▼ or ▲ to select the ring pattern to be assigned to the facsimile number.
 - A:** Standard ring (one long ring)
 - B:** Double ring (two short rings)
 - C:** Triple ring (short-long-short rings)
 - D:** Other triple ring (short-short-long rings)
 - OFF:** Turns off the feature (pre-selected setting).
- 5** Press **START/COPY/SET**.
PRINTING
 - The unit will print an information list.SETUP ITEM []
- 6** Press **MENU**.

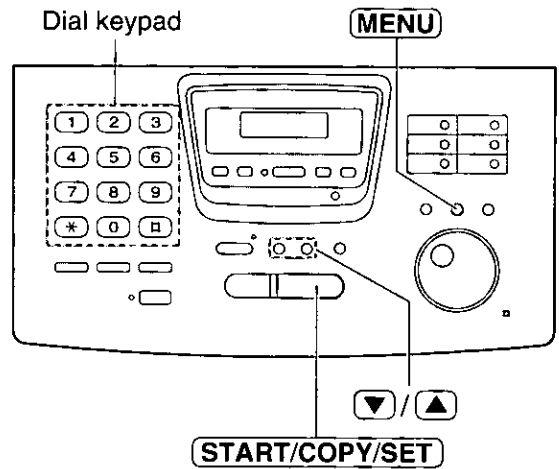

Note:

- The unit will automatically answer a Distinctive Ring call after the second ring irregardless of the AUTO ANSWER, receive mode or ring count setting.
- If you have only 1 Distinctive Ring number, you most likely will use setting "B".

Receiving Faxes

TEL/FAX mode

(receiving voice calls with rings and fax calls without rings when you are near the unit)

Use this mode when you are always near the unit and want the fax machine to detect faxes without ringing. When a call is received, the unit will work as follows. If you connected an extension telephone, see the next page.

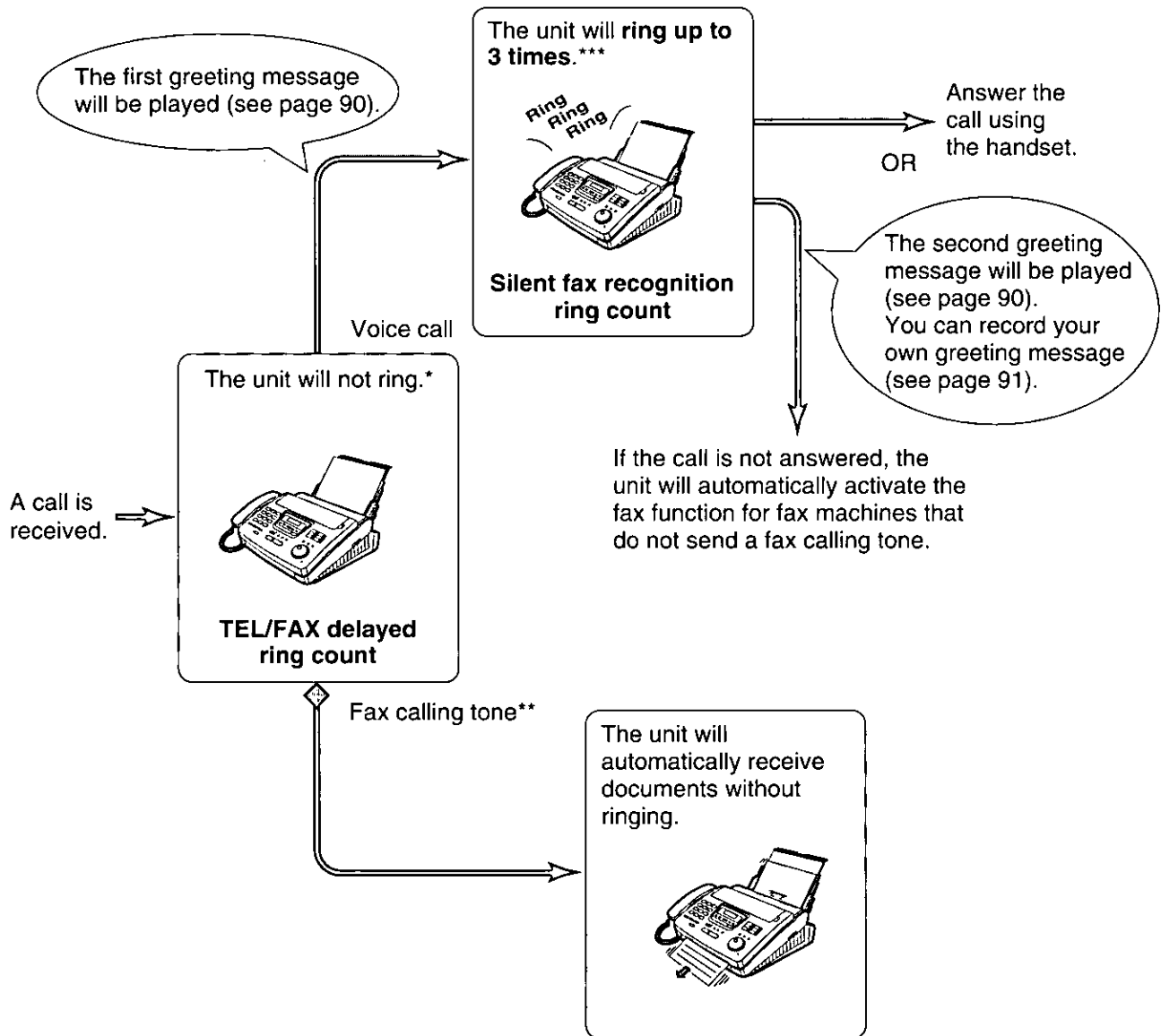

* A telephone fee will be charged to the caller from this point.

** A fax calling tone is automatically generated by the sending fax machine. Some fax machines do not have this capability.

*** While ringing, the unit will emit a different ring back tone to the calling party.

Note:

- o Some fax messages that are transmitted manually may not send a fax calling tone. These calls must be received manually.
- o You must set the ringer to ON.

Ring pattern when an extension telephone is connected

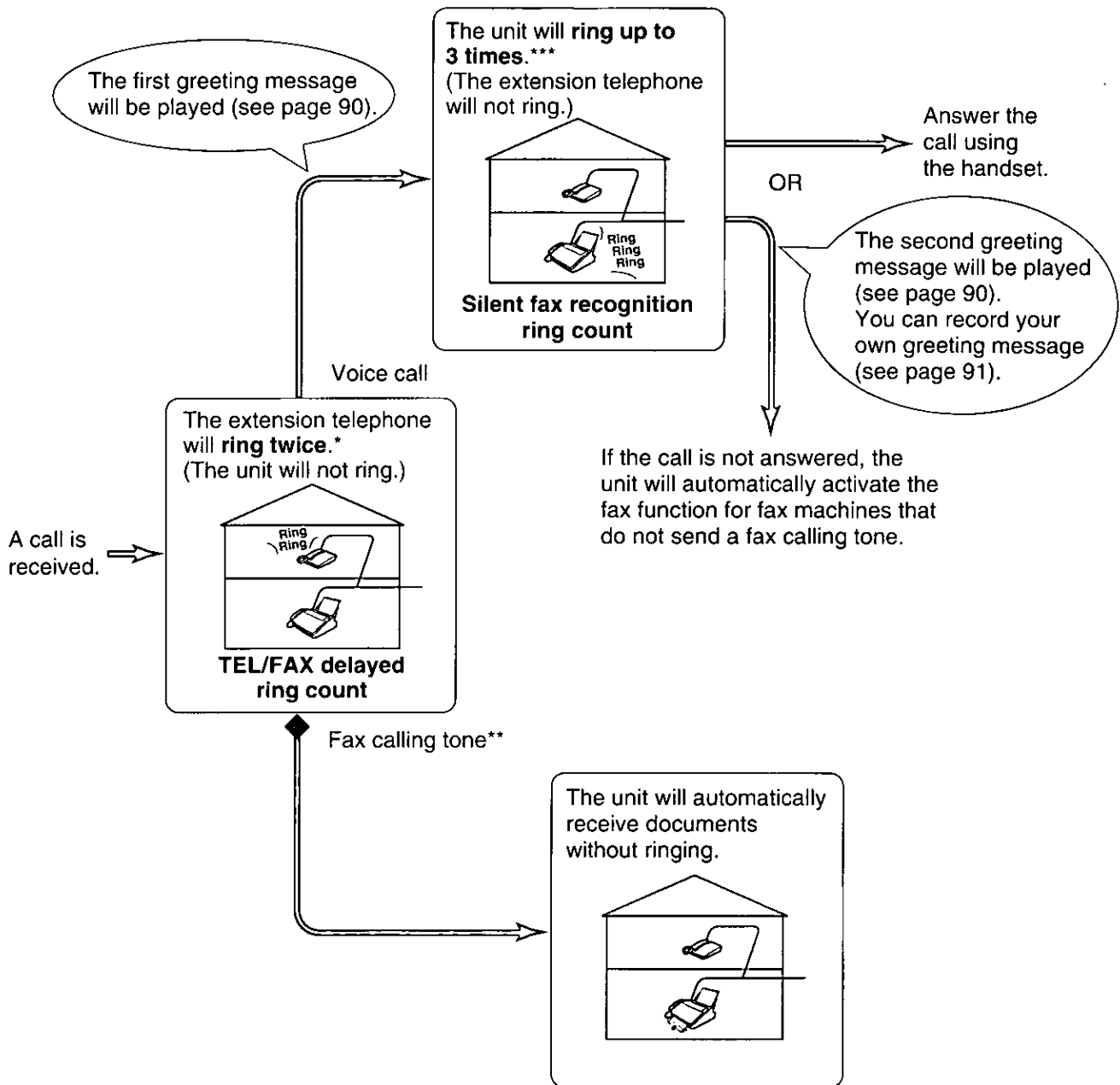

Fax/Copy

TEL/FAX delayed ring count: Up to four ring signals will be generated before the unit answers, depending on feature setting #78 on page 81. In the TEL/FAX mode, the unit will not generate an audible ring during this time.

Silent fax recognition ring count: The unit generates audible rings to indicate that it is receiving a voice call. Three to six rings will be generated, depending on feature setting #30 on page 81. This signal will not ring at an extension telephone.

Note:

- The unit will display the following when the extension telephone starts to ring.

Display: INCOMING CALL

- You must set the ringer to ON.

Receiving Faxes

Changing the AUTO ANSWER setting to the TEL/FAX mode

1 Select "TEL/FAX" in step 4 of feature setting #77 (see page 73).

- The unit will print an information list.

2 If the AUTO ANSWER light is off, turn it on by pressing **AUTO ANSWER**.

- The unit will play the second greeting message of the TEL/FAX mode and the display will show the following message.

Display: TEL/FAX MODE

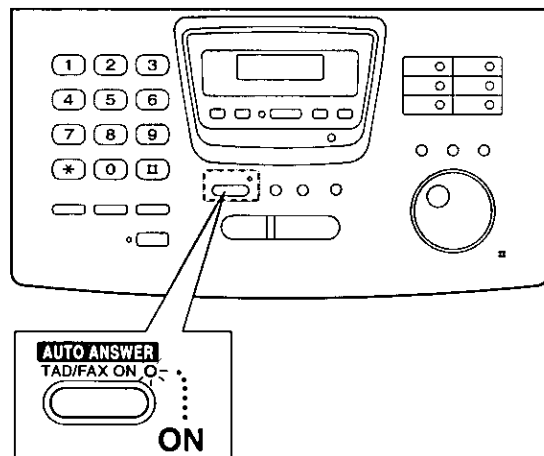

We recommend the following setup.

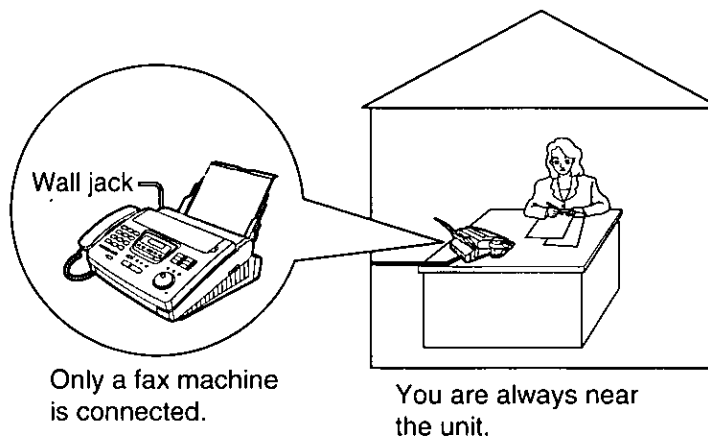

TEL/FAX delayed ring count

This setting determines the number of times the extension telephone rings in the TEL/FAX mode. You can choose from 1 to 4 rings.

When an extension telephone is not connected, this setting does not need to be changed.

- 1 Press **MENU**.
Display: 1. SYSTEM SET UP
- 2 Press **□**, then **7 8**.
TEL/FAX RING
- 3 Press **START/COPY/SET**.
RING=2 ▼▲
- 4 Press ▼ or ▲ to select the desired number, or enter the number using the dial keypad.
- 5 Press **START/COPY/SET**.
SETUP ITEM []
- 6 Press **MENU**.

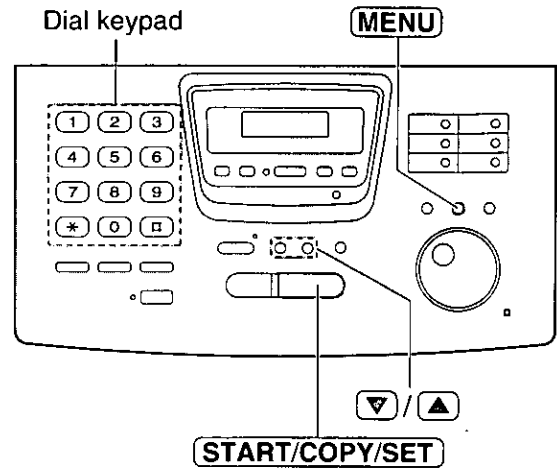

Note:

- If the number of rings is increased, you may not be able to receive documents from some older model fax machines which do not send a fax calling tone.
- If you subscribe to a Caller ID service, set this ring count setting to 2 or more rings.

Silent fax recognition ring count

When the unit detects a voice call in the TEL/FAX mode, it will ring up to 3 times. The number of rings can be changed up to 6. If a voice call is not answered within the selected number of rings (3 to 6 rings), the unit will automatically start to receive a fax.

- 1 Press **MENU**.
Display: 1. SYSTEM SET UP
- 2 Press **□**, then **3 0**.
SILENT FAX RING
- 3 Press **START/COPY/SET**.
RING=3 ▼▲
- 4 Press ▼ or ▲ to select the desired number, or enter the number using the dial keypad.
- 5 Press **START/COPY/SET**.
SETUP ITEM []
- 6 Press **MENU**.

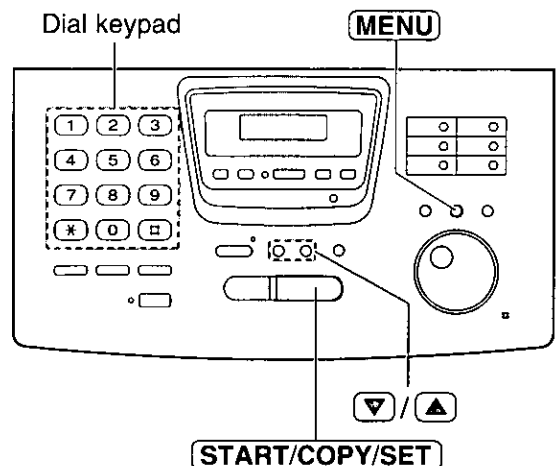

Note:

- If the number of rings is increased, you may not be able to receive documents from some older model fax machines which do not send a fax calling tone.

Receiving Faxes

Extension telephone

When you connect an extension telephone on the same line, you can receive fax documents using the extension telephone.

You do not have to go to the unit and press **START/COPY/SET**.

Important:

- Use a touch tone telephone as the extension telephone and enter the fax activation code **firmly**.

- 1** When the extension telephone rings, lift the handset of the extension telephone.
- 2** When:
 - document reception is required,
 - a fax calling tone (slow beep) is heard, or
 - no sound is heard,press *** 9** (pre-selected fax activation code) **firmly**.
- 3** Hang up the handset.
 - The unit will start reception.

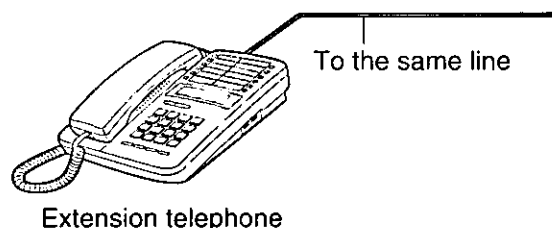

Note:

- You can change the fax activation code (see below).

Fax activation code

The fax activation code is used when receiving faxes using an extension telephone (see above).

Important:

- This code should be different from the remote operation ID (see page 98).

- 1** Press **MENU**.
Display: 1.SYSTEM SET UP
- 2** Press **□**, then **4 1**.
FAX ACTIVATION
- 3** Press **START/COPY/SET**.
MODE=ON ▼▲
- 4** Press ▼ or ▲ to select "ON".
 - If this feature is not required, select "OFF".
- 5** Press **START/COPY/SET**.
CODE= * 9
 - The display will show the pre-selected code.
- 6** Enter the new code number.
 - This code can be from 2 to 4 digits in length using 0 – 9 and *.
- 7** Press **START/COPY/SET**.
SETUP ITEM []
- 8** Press **MENU**.

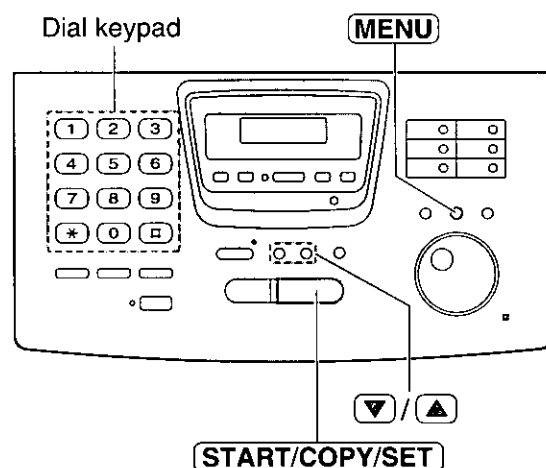

Note:

- If you subscribe to some special telephone company services which require a code, all or part of the fax activation code must be different from the service access code.
- The fax activation code should not be set to "0000".

Other size documents

When the size of the document sent by the other party is as large as, or larger than the recording paper, the unit can reduce each page of the document and print it out on the recording paper by programming a suitable reduction rate.

The reduction rate is determined by a combination of the size of the recording paper and received document.

Recommended reduction rate:

Mode	Size of recording paper	Size of original document
100%	Legal	Letter, A4
92% (pre-selected)	Letter	Letter
	Legal	Legal
86%	Letter	A4
72%	Letter	Legal

Letter = 216 mm x 279 mm (8½" x 11")

Legal = 216 mm x 356 mm (8½" x 14")

A4 = 210 mm x 297 mm (May not be available in the United States.)

Fax/Copy

- 1 Press **MENU**.
Display: 1.SYSTEM SET UP
- 2 Press **[]**, then **[3][6]**.
RCV REDUCTION
- 3 Press **START/COPY/SET**.
MODE=92% ▼▲
- 4 Press ▼ or ▲ to select the desired setting.
● If this feature is not required, press ▲ to select "100%".
- 5 Press **START/COPY/SET**.
SETUP ITEM []
- 6 Press **MENU**.

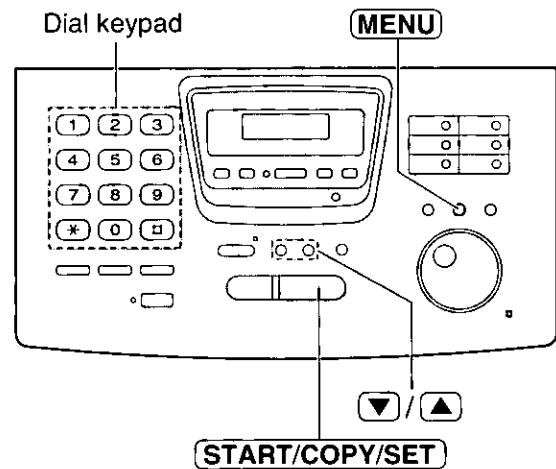

Note:

- Documents usually have a heading on the top of each page which contains the sender's name/telephone number. This increases the length of each page. Therefore, using the reduction mode is recommended.
- If the appropriate reduction rate is not programmed, the document will be divided.

Receiving Faxes

Memory reception alert

When received documents are stored into memory, the unit will alert you with beep tones. If you hear slow beeps, clear the printing problem or supply paper to print the stored documents. The beep tones will stop.

- 1 Press **MENU**.
Display: 1.SYSTEM SET UP
- 2 Press **□**, then **4 4**.
RECEIVE ALERT
- 3 Press **START/COPY/SET**.
MODE=ON ▽ ▲
- 4 Press **▽** or **▲** to select the desired setting.
o If this feature is not required, select "OFF".
- 5 Press **START/COPY/SET**.
SETUP ITEM []
- 6 Press **MENU**.

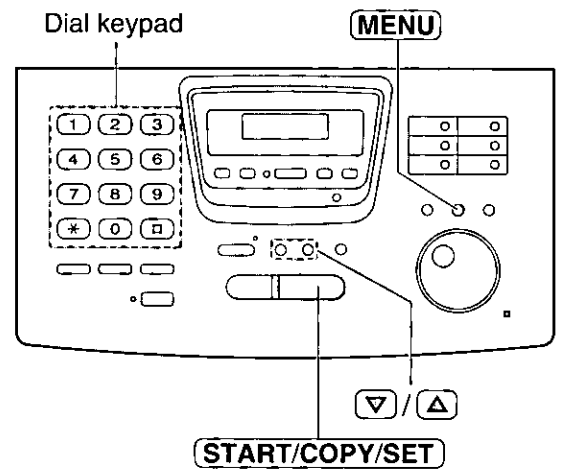

Friendly reception

The friendly reception feature allows you to receive fax documents automatically without pressing **START/COPY/SET** (see page 72).

When this feature is deactivated, you have to press **START/COPY/SET** to receive fax documents each time you answer a fax call.

- 1 Press **MENU**.
Display: 1.SYSTEM SET UP
- 2 Press **□**, then **4 6**.
FRIENDLY RCV
- 3 Press **START/COPY/SET**.
MODE=ON ▽ ▲
- 4 Press **▽** or **▲** to select the desired setting.
o If this feature is not required, select "OFF".
- 5 Press **START/COPY/SET**.
SETUP ITEM []
- 6 Press **MENU**.

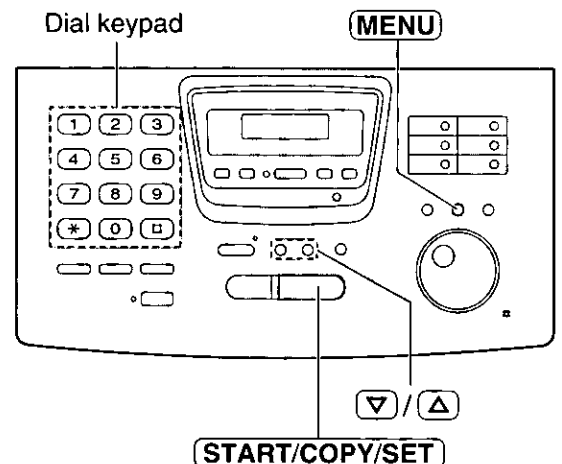

Pager call - when your unit receives a fax

This feature allows your unit to call your pager when your unit receives a fax document.

1 Press **MENU**.
 Display: 1. SYSTEM SET UP

2 Press **[FAX]**, then **[7] [0]**.
 FAX PAGER CALL

3 Press **START/COPY/SET**.
 MODE=OFF ▼▲

4 Press ▼ or ▲ to select "ON".
 MODE=ON ▼▲

• If this feature is not required, select "OFF".

5 Press **START/COPY/SET**.
 NO. =

6 Enter your pager number.
 • You can enter a total of 46 digits and/or pauses.
 Example:
 1 202 555 1234 PPP 12345678 PPP 5555#
 Your pager number Pauses Your pager access code, if required. Message you want displayed on your pager when your unit receives a fax.

7 Press **START/COPY/SET**.
 • The unit will dial the stored number.
 PAGER TEST

8 Confirm if the message is displayed on your pager.

9 Press **DIGITAL SP-PHONE**.

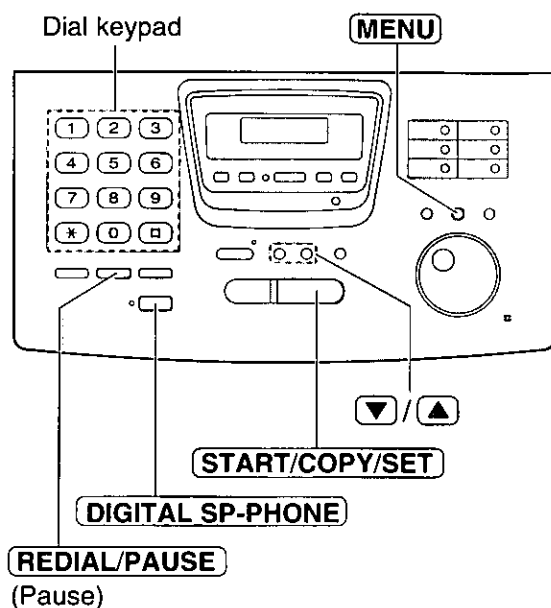

Fax/Copy

How your unit and pager work

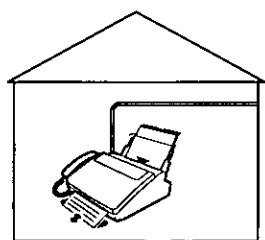

When your unit receives a fax document, it will call your pager company.

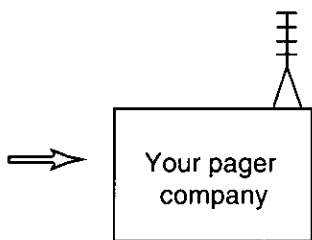

Your pager company will call your pager.

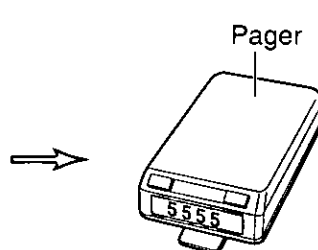

A few minutes later, your pager will display the same message you entered in step 6. (For example: 5555)

Receiving Faxes

Film detection

If this feature is activated, the display will show the following message when the remaining film prints about 15 letter size documents.

Display: FILM NEAR EMPTY

o If you are using regular film (100 m roll) when the above message is displayed, the unit will also print a report.

- 1 Press **MENU**.
Display: 1.SYSTEM SET UP
- 2 Press **[]**, then **[7][9]**.
FILM DETECTION
- 3 Press **START/COPY/SET**.
MODE=ON ▽ ▲
- 4 Press **▽** or **▲** to select the desired setting.
o If this feature is not required, select "OFF".
- 5 Press **START/COPY/SET**.
SETUP ITEM []
- 6 Press **MENU**.

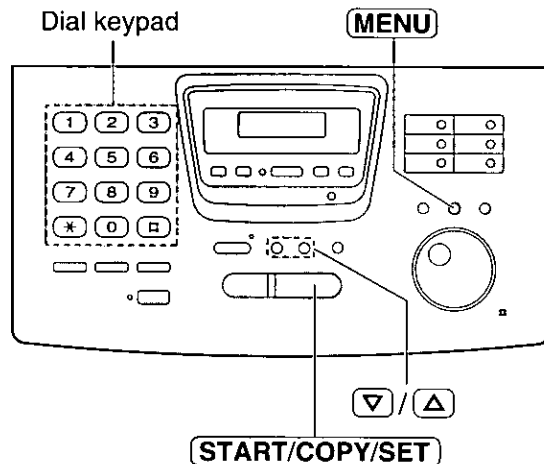

Making a copy

The unit can make single or multiple copies (up to 99). Any transmittable document (see page 60) can be copied.

- 1 Open the document feeder tray.
 - If the display shows "CHECK PAPER", make sure you **pull the recording paper set lever forward** when installing paper.
- 2 Adjust the width of the document guides to the size of the document.
- 3 Insert the document (up to 15 pages) **FACE DOWN** until a single beep is heard and the unit grabs the document.

Display: STANDARD

- Make sure the handset is on the unit.
- 4 If necessary, press **RESOLUTION** repeatedly to select the desired setting (see the bottom of page 54).

- 5 Press **START/COPY/SET**.

NUMBER=1 [100%]

- 6 Enter the number of copies (up to 99).

- 7 If necessary, choose an enlargement/reduction rate by pressing **ZOOM** (∇ / \blacktriangle). See page 88.
 - If you select "200%", you cannot make multiple copies (see the instructions on the right) or change the resolution.

- 8 If you want to make collated copies, press **COLLATE** until the following is displayed. See the instructions on page 88.

COLLATE=ON

- 9 Press **START/COPY/SET**.
 - The unit will start printing.

COPYING

Note:

- If a resolution is not selected, FINE resolution will automatically be selected.
- You can make or receive a voice call while making copies.
- After copying, the enlargement/reduction rate setting will return to "100%".

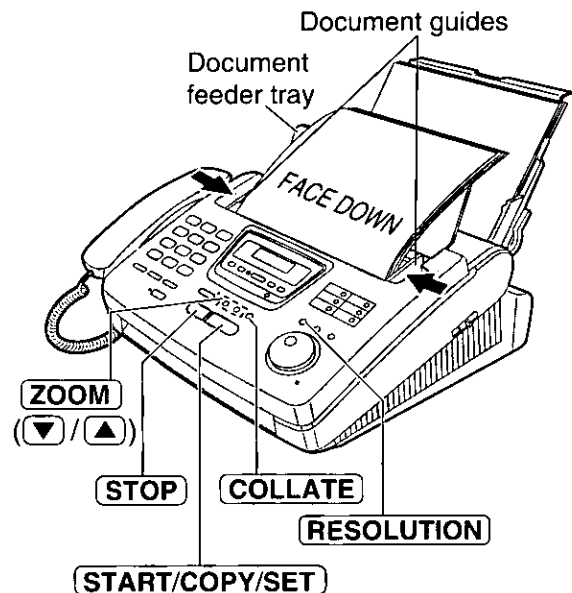
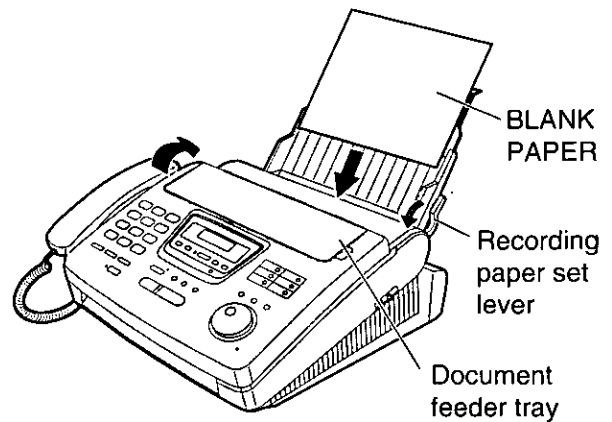

Fax/Copy

To stop copying

Press **STOP**.

To eject the document, press **STOP** again.

To make multiple copies of an enlarged document

Make a single enlarged copy by selecting "200%" using **ZOOM** (\blacktriangle) first. Then make multiple copies of the enlarged document.

Copying

Printing collated copies

The unit will print uncollated copies. You can also print collated copies. See the example below.

Example: Making two copies of a 4 page original document.

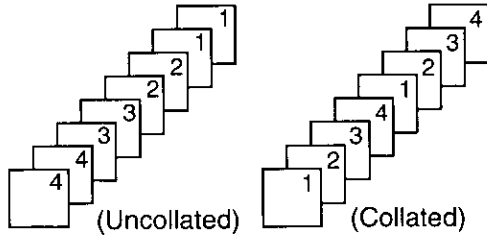

- If you turn the collating feature on, the unit will store the document into memory and print it. If memory becomes full while storing, the unit will only print out the stored pages.
- After copying, the collating feature will turn off automatically.

Choosing an enlargement/reduction rate

The unit can make enlarged or reduced copies of a document.

■ To enlarge a document:

Select "200%" by pressing **ZOOM** (\blacktriangle), then insert the document into the unit from the top side. The unit will only enlarge the center part of the top half of the document. See the example below.

Sample of an enlarged copy:

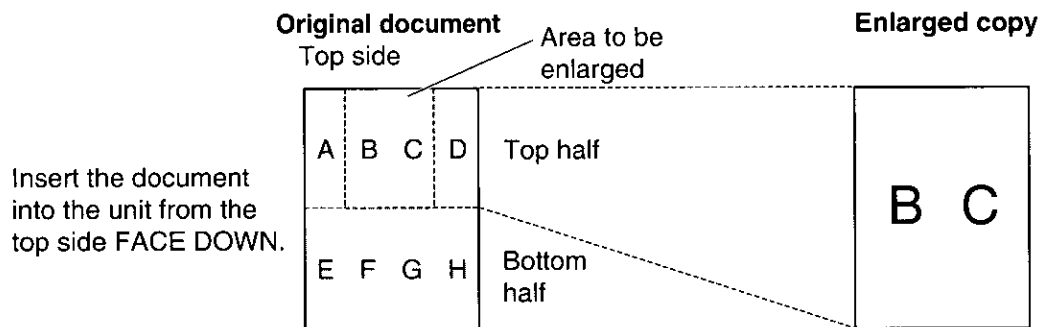

■ To reduce a document:

When you copy documents that are longer than the recording paper, the unit can reduce the original document by programming a suitable reduction rate. The reduction rate is determined by the size of the recording paper and original document. Select from 100%, 92%, 86% and 72% by pressing **ZOOM** (\blacktriangledown / \blacktriangle).

Recommended reduction rate:

Mode	Size of recording paper	Size of original document
100% (pre-selected)	Letter	Letter
	Legal	Letter, A4, Legal
92%	Letter	A4
86%	Letter	A4
72%	Letter	Legal

Letter = 216 mm x 279 mm (8½" x 11")

Legal = 216 mm x 356 mm (8½" x 14")

A4 = 210 mm x 297 mm (May not be available in the United States.)

Note:

- If the appropriate reduction rate is not programmed, the document may be divided and the top of the second sheet will be deleted.

TAD/FAX mode

(using the built-in answering device and receiving voice and fax calls automatically)

When you turn on AUTO ANSWER (the pre-selected setting is TAD/FAX), the unit will work as a facsimile machine and/or answering device.

If a fax call is detected, the unit will automatically switch to receive faxes.

If a voice call is detected, the answering device will begin recording and the caller can leave a voice message.

- You can use a pre-recorded greeting message (see page 90) or record your own greeting message (see page 91).

Setting up the voice message and document reception

The total recording time (including the greeting messages) is about 18 minutes. If messages are recorded in a noisy room, the recording time may be shortened up to 11 minutes.

To set the unit to record incoming voice messages and receive fax documents, follow the steps below.

- 1 Select "TAD/FAX" in step 4 of feature setting #77 (see page 73).

- 2 If the AUTO ANSWER light is off, turn it on by pressing **AUTO ANSWER**.

- The unit will play the TAD/FAX greeting message and the display will show the following message.

Display: TAD/FAX MODE

The remaining time for recording incoming messages will be displayed.

Example: TIME = 10m13s

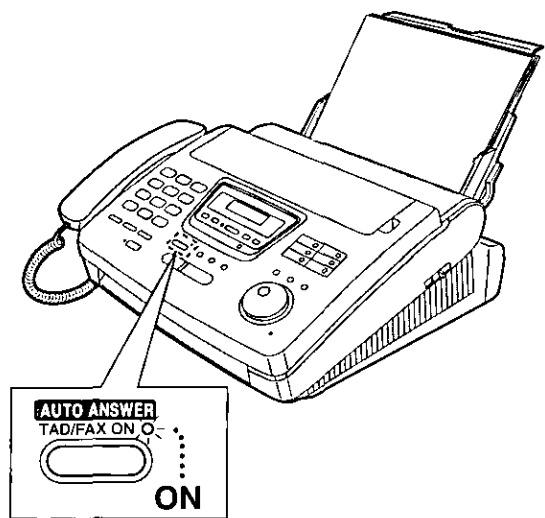

Note:

- Each incoming message recording time can be set to either 1 minute or unlimited. To change the setting, see page 106.
- When the remaining time is low, erase unnecessary messages from memory (see pages 94 and 100).
- While an incoming call is being recorded, you can monitor it through the speaker. If this feature is not required, set the ICM monitor feature to "OFF" (see page 107).

Greeting

Pre-recorded greeting messages

The unit has pre-recorded greeting messages. Depending on the situation, one of the following messages will be played to the caller.

- When you do not record your own greeting message (next page), one of the following messages will be played according to the AUTO ANSWER setting (TAD/FAX mode or TEL/FAX mode).

TAD/FAX mode

*Hello! We are unable to answer right now.
To send a fax, please start transmission.
To leave a voice message, please speak after the beep.
Thank you.*

TEL/FAX mode

First greeting message

*Hello! To send a fax, start transmission.
To speak with someone, please wait.*



Second greeting message

*No one is available to take your call right now.
Please try again later.
Thank you.*

Note:

- If you erase your own greeting messages, one of the pre-recorded greeting messages will be played automatically.

- When the unit detects a problem in the TAD/FAX mode, one of the following pre-recorded greeting messages will be played.

MESSAGE FULL

*Hello! We are unable to answer right now.
To send a fax, please start transmission.
To leave a voice message, please try again later.
Thank you.*

FAX MEMORY FULL

*Hello! We are unable to answer right now.
To send a fax, please try again later.
To leave a voice message, please speak after the beep.
Thank you.*

MESSAGE FULL
and
FAX MEMORY FULL

*Hello! We are unable to answer right now.
Please try again later.
Thank you.*

Recording your own greeting messages

The recording time is limited to 16 seconds for each message. Record your message within 12 seconds for best performance.

- You can choose either 16 seconds or 60 seconds of recording time for the TAD/FAX greeting message (see page 93).

Suggested messages

TAD/FAX greeting message	<i>"This is (your name, business and/or telephone number). We are unable to answer right now. To send a fax, start transmission. To leave a message, speak after the beep. Thank you."</i>
TEL/FAX greeting message	<i>"This is (your name, business and/or telephone number). We are unable to answer right now. Please try again later. Thank you."</i>

Note:

- If you do not record any messages, one of the pre-recorded messages will be played (see page 90).

Recording a greeting message

- Make sure that the AUTO ANSWER setting is set to the desired mode (TAD/FAX or TEL/FAX mode) where you want to record a greeting message (see page 73).

- Press **RECORD** two times.

- The display will show one of the following according to your selection in step 1.

For the TAD/FAX greeting:

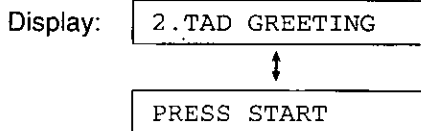

For the TEL/FAX greeting:

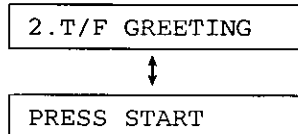

- Press **START/COPY/SET**.

- A long beep will sound.
- The display will show one of the following according to your selection in step 1.

For the TAD/FAX greeting:

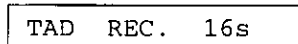

For the TEL/FAX greeting:

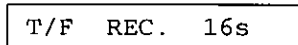

- Speak clearly about 20 cm (8 inches) away from the microphone.

- The display will show the remaining recording time.

Example: TAD/FAX greeting

TAD REC. 15s

- When finished, press **STOP**.

- The unit will repeat your message. You can adjust the volume using **▼** or **▲**.

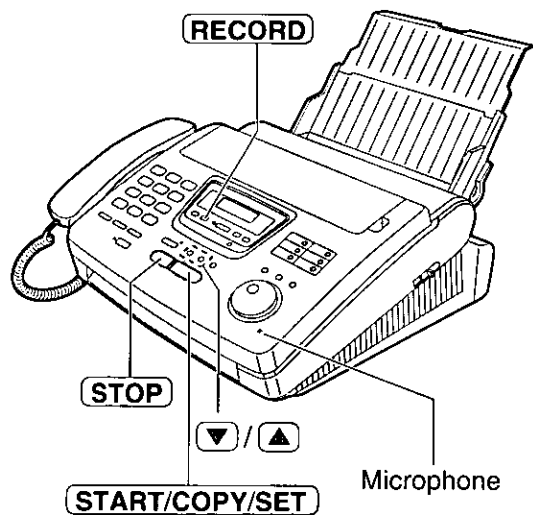

Answering Device

Note:

- If you make a mistake while recording, repeat from step 2.
- If you record a TEL/FAX greeting message, it will be played as the second greeting message. The first greeting message will always play even if a TEL/FAX greeting message is recorded (see page 90).

Greeting

Erasing your own recorded greeting messages ==

1 Make sure that the AUTO ANSWER setting is set to the desired mode (TAD/FAX or TEL/FAX mode) where you want to erase the greeting message (see page 73).

2 Press **ERASE** two times.
• The display will show one of the following according to your selection in step 1.
For the TAD/FAX greeting:

Display:

2.TAD GREETING

↓

PRESS START

For the TEL/FAX greeting:

2.T/F GREETING

↓

PRESS START

3 Press **START/COPY/SET**.

ERASE GREETING?

↓

YES: PRESS SET

• To stop erasing, press **STOP**.

4 Press **START/COPY/SET**.

GREETING ERASED

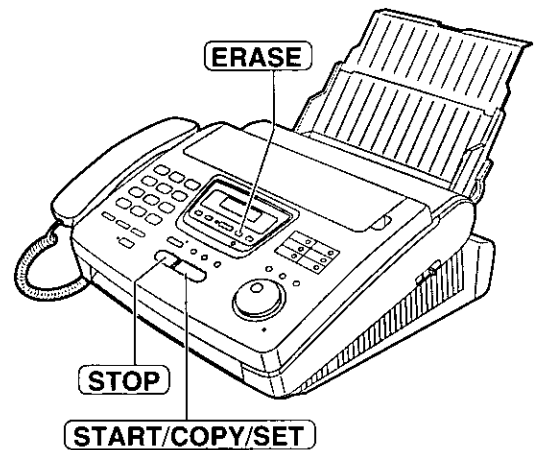

Note:

- If you erase your own recorded greeting messages, the pre-recorded greeting messages will be played.

Recording time for the TAD/FAX greeting message

You can choose either 16 seconds or 60 seconds of recording time.

- 1 Press **MENU**.
Display: 1.SYSTEM SET UP
- 2 Press **□**, then **5** **4**.
GREETING TIME
- 3 Press **START/COPY/SET**.
MODE=16s ▼▲
- 4 Press ▼ or ▲ to select the desired setting.
- 5 Press **START/COPY/SET**.
SETUP ITEM []
- 6 Press **MENU**.

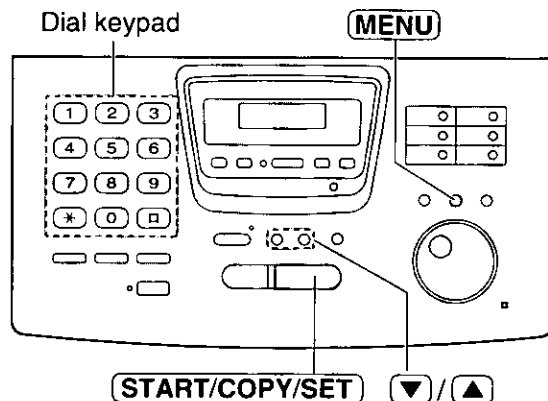

Note:

- If you change the greeting message time to 60 seconds, we recommend that you tell the caller in the TAD/FAX greeting message to press *9 before starting fax transmission.
- If you change the greeting message time to 16 seconds from 60 seconds, your recorded TAD/FAX greeting message will be deleted. Re-record a greeting message (see page 91).

Answering Device

Playing Messages

Listening to recorded messages

When the unit receives voice messages;

- the PLAY MESSAGES light will flash,
- the call counter will show the total number of recorded messages, and
- slow beeps will sound if message alert (page 106) is set to "ON".

When the PLAY MESSAGES light is flashing

Press **PLAY MESSAGES**.

- o Only the new recorded messages will be played.

When the PLAY MESSAGES light is on

Press **PLAY MESSAGES**.

- o All messages will be played.

Note:

- o During playback, the display shows the recorded order of the messages.
- o You can adjust the speaker volume using **▽** or **△**.
- o The number of calls in the call counter will not decrease until you erase the recorded messages.

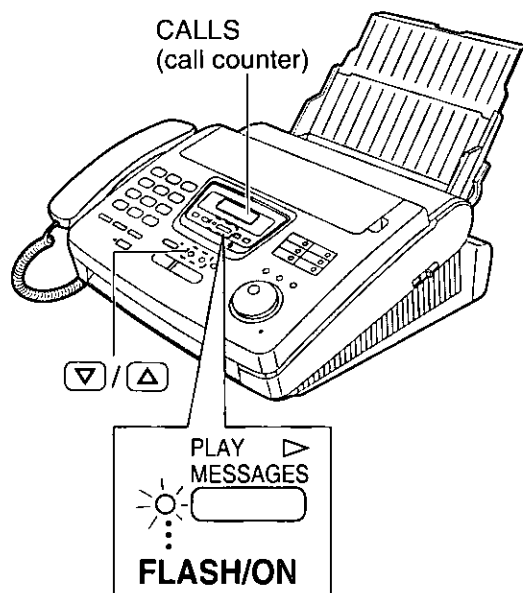

Voice time/day stamp:

During playback, a synthesized voice will announce the time and day of the week when each message was recorded.

Erasing recorded messages

Erase unnecessary messages to prevent memory from becoming full.

Erasing a specific message

Press **ERASE** while listening to the message you want to erase.

Erasing all the messages

1. Press **ERASE** after listening to all of the messages.

Display: 1. ALL MESSAGES



PRESS START

2. Press **START/COPY/SET**.

ERASE MESSAGES?



YES: PRESS SET

- o To stop erasing, press **STOP**.

3. Press **START/COPY/SET**.

ERASING

ERASE COMPLETED

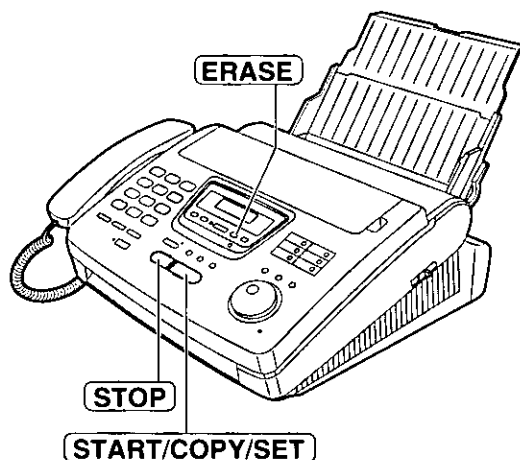

Functions while playing a message

(repeating, skipping and stopping)

Repeating a message

Rotate **JOG DIAL** one click to the left while listening to the message you want to repeat.

- If you rotate **JOG DIAL** within 5 seconds of the beginning of the message, the previous message will be played.
- To play back a specific message, rotate **JOG DIAL** to the left until you hear the message you want to repeat.

Skipping a message

Rotate **JOG DIAL** one click to the right to play the next message.

Changing the playback speed

Press **QUICK** to play messages at one and a half times the original speed.

Press **SLOW** to play messages at a half the original speed.

- To return to the original speed, press **QUICK** or **SLOW** again during quick or slow playback.

Stopping playback

Press **STOP**.

- To resume playing the recorded messages, press **PLAY MESSAGES** within 1 minute.

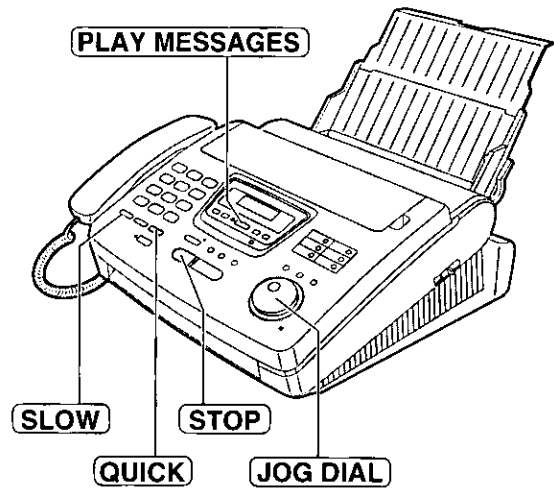

Recording

Memo message

(leaving a message for others or yourself)

To leave a private message for someone or yourself, you can record a voice memo. This memo can be played back later, either directly or remotely.

- 1 Press **RECORD**.

Display: 1.MEMO MESSAGE



PRESS START

- 2 Press **START/COPY/SET**.
• A long beep will sound.

MEMO RECORDING

- 3 Speak clearly into the microphone.

- 4 When finished, press **STOP**.

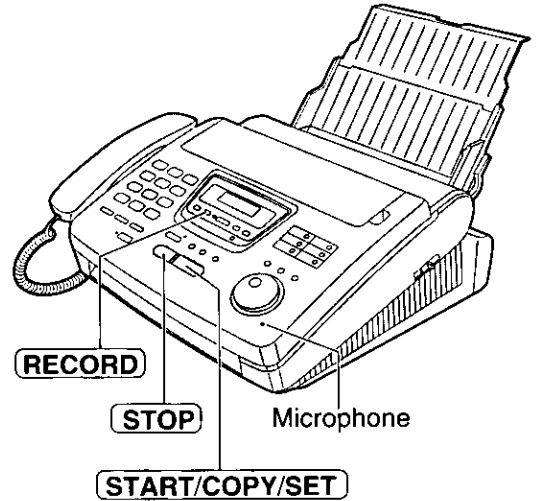

Telephone conversation

You can record a telephone conversation.

- 1 During the telephone conversation, press **RECORD**.

Display: 2WAY RECORDING

- 2 To stop recording, press **STOP** or hang up the handset.

Note:

- This feature is not available when using the DIGITAL SP-PHONE button.
- There may be legal restrictions in your state on recording two way telephone conversations. Inform the other party that the conversation is being recorded.

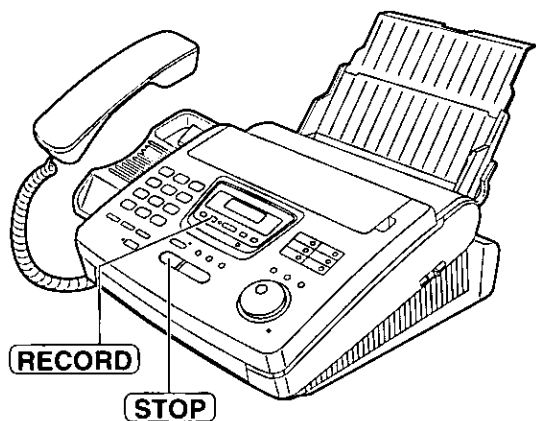

Operating from a remote location

The following operations can be performed from a remote location using a touch tone telephone.
Set the unit to the TAD/FAX mode before going out (see page 89).

Dial key	Remote command	Page	Dial key	Remote command	Page
0	Skips the greeting message	101	9	Stops re-recording of a greeting message	101
1	Repeats a message	99	*4	Erases a specific message	100
2	Skips a message	99	*5	Erases all messages	100
4	New message playback	99	80	Changes to the TEL mode	101
5	All message playback	99	81	Turns ON message transfer/pager call for incoming messages	101
6	Room monitor	100	82	Turns OFF message transfer/pager call for incoming messages	101
7	Re-records a greeting message	101			

Remote operation card

Please cut out and carry this card for assistance when using the remote operation.

Answering Device

Answering Device Remote Operation	Notice of Remote Operation
<ol style="list-style-type: none"> 1. Call your unit. 2. Enter the remote operation ID <input type="text"/> <input type="text"/> during the greeting message. <ul style="list-style-type: none"> ● The new recorded messages will be played automatically. 3. Press the remote command key(s) (see the reverse side) within 10 seconds. <hr style="width: 50%; margin-left: 0;"/> <p>If there is no new message, press the remote command key(s) within 4 seconds. or Wait for 4 seconds, and all the recorded messages will be played back.</p>	<ul style="list-style-type: none"> ● The remote operation is available only from a touch tone telephone when the unit is in the TAD/FAX mode. ● When the unit is in the TEL mode, call your unit and wait for 15 rings. The answering device will temporarily answer the line. Enter the remote operation ID during the greeting message. The unit will switch to the TAD/FAX mode. ● When you press any key, press firmly. ● To send a document, press *9. When a fax tone is heard, start transmission.

Fold here

Remote Operation

Setting the remote operation ID

The remote operation ID is used to access the answering device. Choose any 3-digit number except a number using digits 0 or 7.

- 1 Press **MENU**.
Display: 1.SYSTEM SET UP
- 2 Press **▣**, then **1 1**.
REMOTE TAD ID
- 3 Press **START/COPY/SET**.
ID=111
- 4 Enter the desired number.
- 5 Press **START/COPY/SET**.
SETUP ITEM []
- 6 Press **MENU**.

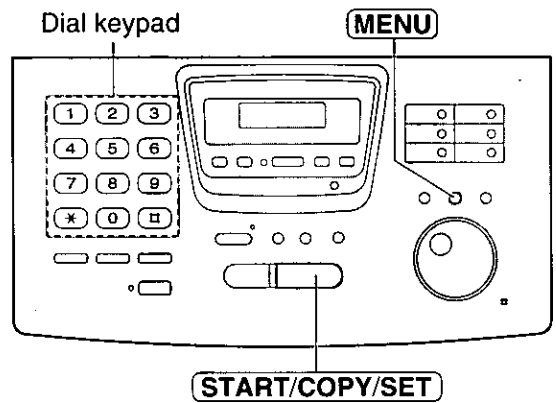

Key	Remote command
0	Skips the greeting message
1	Repeats a message
2	Skips a message
4	New message playback
5	All message playback
6	Room monitor
7	Re-records a greeting message

Key	Remote command
9	Stops re-recording of a greeting message
*4	Erases a specific message
*5	Erases all messages
80	Changes to the TEL mode
81	Message transfer/ Pager call ON
82	Message transfer/ Pager call OFF

From a remote touch tone telephone --- ---

Listening to messages

- 1** Call your unit.
- 2** Enter the remote operation ID during the TAD/FAX greeting playback.
 - The voice guide will tell you the number of new recorded messages and play them automatically.
 - You can repeat the new recorded messages by pressing **4** in the same call.
- 3** Press **5** to listen to all of the recorded messages.

Voice guide example:

3 new messages.

When there is no new recorded message

The voice guide will tell you *"No new messages."* in step 2.

Press **5** or wait for 4 seconds to listen to all of the recorded messages.

During playback

Repeating a message

Press **1** to play the current message.

—If you press **1** within 5 seconds of the beginning of a message, the previous message will be played.

Skipping a message

Press **2**.

Note:

- If the voice guide prompts you that memory is full after playing the message, erase some or all of the messages.

Voice guide example:

Sorry, no more memory. Please erase unnecessary messages.

Remote Operation

Erasing incoming messages from memory

Erasing a specific message

Press **[*] 4** while listening to the message you want to erase.

- A long beep and the voice guide will be heard.
Then the unit will continue with the next message.

Voice guide example:

The message has been erased.

Erasing all messages

Press **[*] 5** to erase all messages.

- A long beep and the voice guide will be heard.

Voice guide example:

All messages have been erased.

Other remote operations

Monitoring the room

You can monitor the sound in the room where the unit is installed.

Press **[6]**.

- You can monitor the room sound for about 30 seconds.

Note:

- After 30 seconds, a beep sounds. To continue monitoring, press **[6]** again within 10 seconds.

Recording a marker message

After playing back the recorded messages, you can leave an additional message.

1. Wait for the voice guide to tell you that the remote operation has ended.
2. Wait about 10 seconds for the voice guide to prompt you to leave a message.
3. Leave a message after the beep.

Voice guide example:

All messages have been played.

Please leave your name and message after the beep.

Re-recording a greeting message

You can change the contents of the greeting message for the TAD/FAX mode.

1. Press **7** to start recording.
 - A long beep will sound.
2. Speak clearly up to 16 seconds.
 - If you pause for over 2 seconds, 6 beeps will sound and the recording will stop. Repeat from step 1 within 10 seconds.
3. When finished, press **9**.
 - The new greeting message will be played.

Changing to the TEL mode

You can change the setting of the receive mode from TAD/FAX to TEL from a remote location.

1. Call your unit.
2. Enter your remote operation ID.
3. Press **8 0**.

Turning the message transfer/pager call on or off

You must pre-program a transfer telephone number or a pager number (see page 104) before using this feature.

Press **8 1** to turn ON the message transfer/pager call.

Press **8 2** to turn OFF the message transfer/pager call.

— If a transfer telephone number or a pager number is not programmed, you cannot turn this feature ON. The voice guide will prompt you.

Voice guide example:

*Message transfer is set.
Transfer phone number is 123456789.
or
Pager call is set.
Pager number is 098765432.*

*Message transfer is off.
or
Pager call is off.*

*Transfer phone number is not set.
or
Pager number is not set.*

Skipping the greeting message

Press **0** during the greeting message playback.

— The unit will skip the rest of the greeting message.

Transferring recorded messages to another phone

This feature allows your unit to call a designated telephone or pager number each time an incoming voice message is recorded.

You can choose **Message transfer** or **Pager call**.

Message transfer: Program the transfer telephone number first. When an incoming message is recorded in your unit, the message will be transferred. You can retrieve the message during the same call using the remote operation.

Pager call: Program the pager number first. When an incoming call is recorded, your pager will be called. Call your unit and retrieve the message using the remote operation.

- This feature operates in the TAD/FAX mode.
- For details on the remote operation, see page 97.
- Use a touch tone telephone to access your unit.

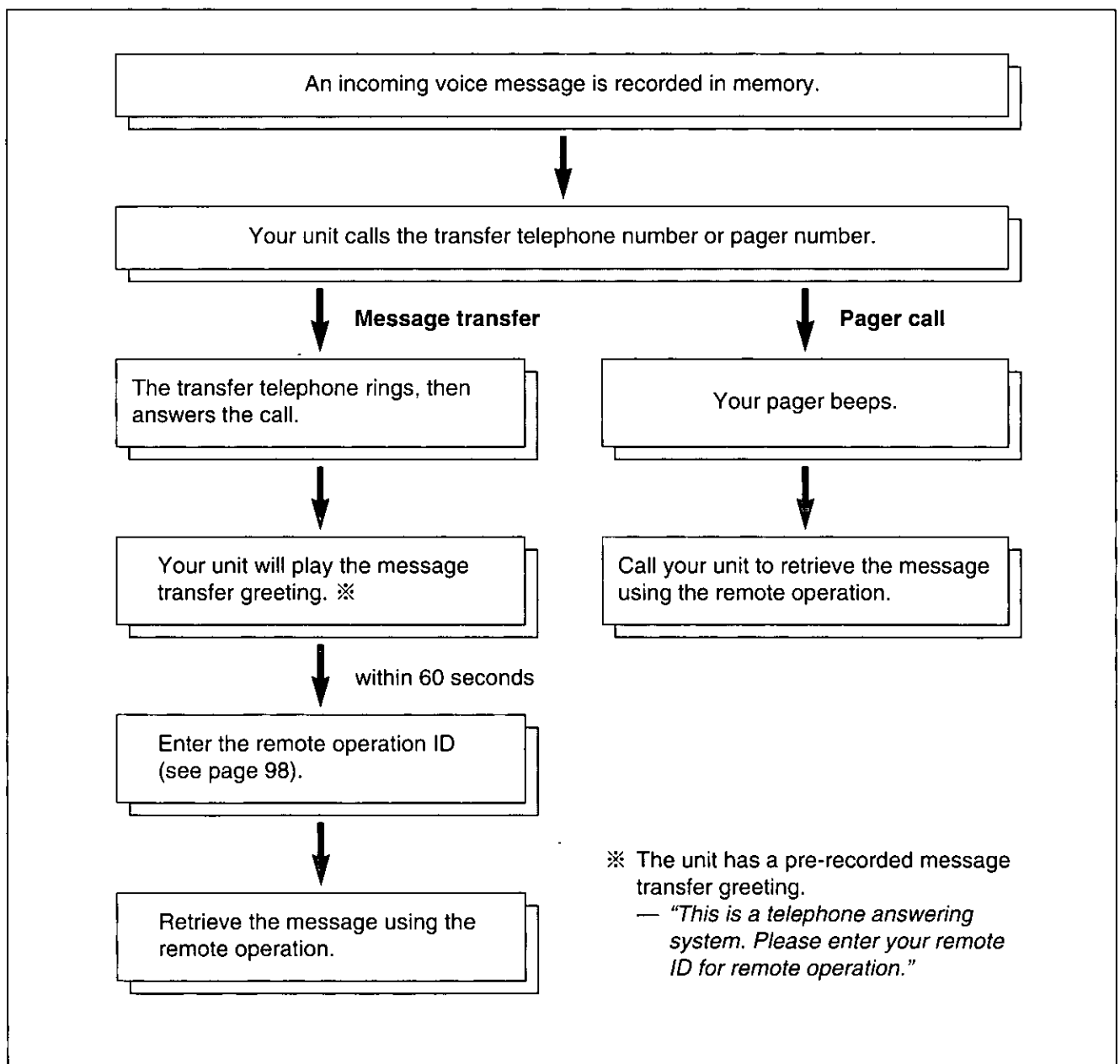

Recording a message transfer greeting message

The recording time is limited to 16 seconds. Record your message within 12 seconds for best performance.

Suggested message

Message transfer greeting message	<i>"This is a transferred message from (your name, business and/or telephone number). Please enter your remote ID for the remote operation."</i>
-----------------------------------	--

Note:

- If you do not record a message, the pre-recorded message will be played (see page 102).

- 1 Press **MENU**.
Display: **1.SYSTEM SET UP**
- 2 Press **□**, then **6 1**.
TRNS-GREETING
- 3 Press **START/COPY/SET**.
CHECK ▼▲
- 4 Press ▼ or ▲ to select "RECORD".
RECORD ▼▲
- 5 Press **START/COPY/SET**.
TRNS REC. 16s
- 6 Speak clearly about 20 cm (8 inches) away from the microphone.
• The display will show the remaining recording time.
Example: **TRNS REC. 15s**
- 7 When finished, press **STOP**.
• The unit will repeat your message. You can adjust the volume using ▼ or ▲.
- 8 To exit the program, press **MENU**.

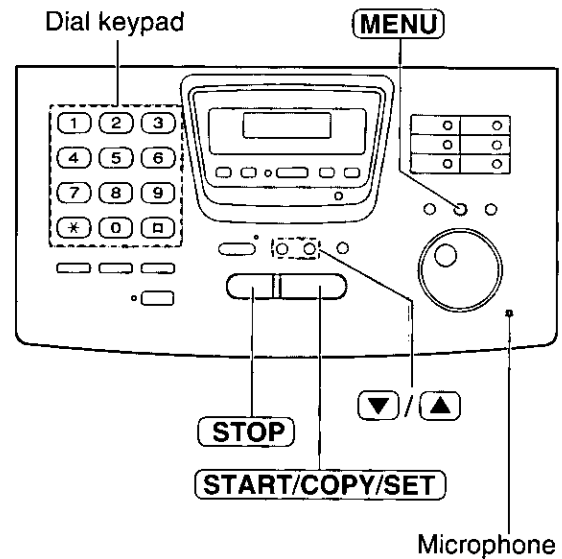

To check your message

Select "CHECK" by pressing ▼ or ▲ in step 4, and press **START/COPY/SET**.

- The unit will play your message.
- To exit the program, press **MENU**.

To erase your message

Select "ERASE" by pressing ▼ or ▲ in step 4, and press **START/COPY/SET**.

To exit the program, press **MENU**.

- The pre-recorded greeting message will be played instead of your message.

Options

Setting the message transfer/pager call

1 Press **MENU**.
Display: 1. SYSTEM SET UP

2 Press **□**, then **6 0**.
MESSAGE TRANS.

3 Press **START/COPY/SET**.
MODE=OFF ▼▲

4 Press ▼ or ▲ to select "MESSAGE" or "PAGER".
MESSAGE: transfers incoming messages.
PAGER: calls your pager.
OFF: turns off this feature.
● If this feature is not required, select "OFF".

5 Press **START/COPY/SET**.
NO. =

6 a: If you selected "MESSAGE" in step 4:
Enter the transfer telephone number.
b: If you selected "PAGER" in step 4:
Enter your pager number.
● You can enter a total of 46 digits and/or pauses.

Example:

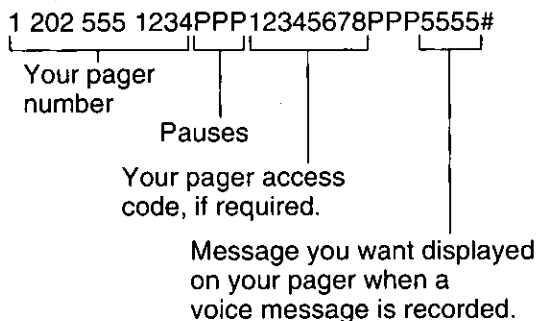

7 Press **START/COPY/SET**.
SETUP ITEM []

8 Press **MENU**.

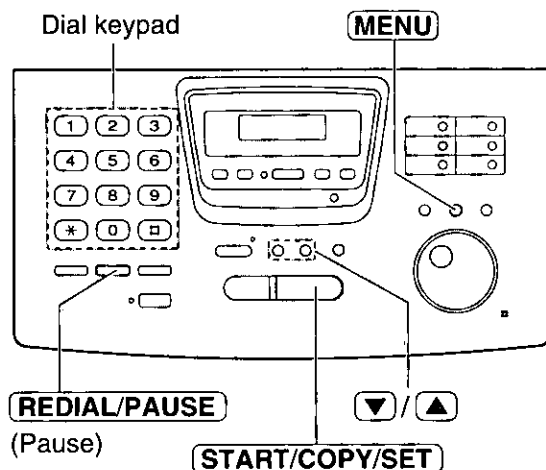

Note:

- This feature can be turned on/off remotely from a touch tone telephone (see page 101).

How your unit and pager work

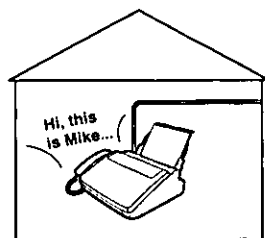

When your unit receives a voice message, it will call your pager company.

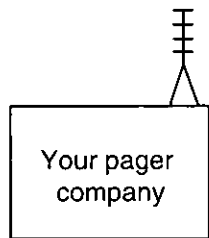

Your pager company will call your pager.

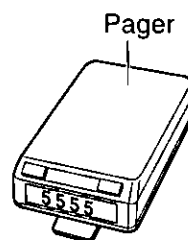

A few minutes later, your pager will display the same message you entered in step 6. (For example: 5555)

Ring count in the TAD/FAX mode

This feature determines the number of rings before the unit answers a call in the TAD/FAX mode. You can choose from 1, 2, 3, 4, TOLL SAVER and RINGER OFF.

TOLL SAVER: When you call the unit from a remote location, the number of rings will tell you if there are any new voice messages. If the unit answers on the second ring, there is at least one new recorded message. If the unit answers on the fourth ring, there are no new recorded messages. To save the toll charges for the call, hang up immediately when you hear the third ring. The third ring indicates that there are no new recorded messages.

RINGER OFF: The unit will answer without ringing.

Helpful hints:

- To answer a call before the unit does, increase the number of rings.
- If you find difficulty in receiving faxes from machines that have an automatic transmission feature, decrease the number of rings.

1 Select "TAD/FAX" in step 4 of feature setting #77 (see page 73).

2 Press **MENU**.

Display: 1.SYSTEM SET UP

3 Press **□**, then **0 6**.

TAD RING COUNT

4 Press **START/COPY/SET**.

RING=2 ▼▲

5 Press ▼ or ▲ to select the desired setting.

6 Press **START/COPY/SET**.

SETUP ITEM []

7 Press **MENU**.

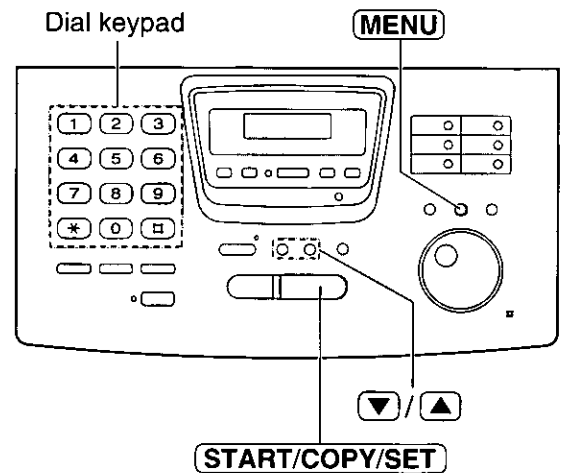

Note:

- If you subscribe to a Caller ID service, set this ring count setting to 2 or more rings.

Options

Incoming message recording time

You can choose from two recording times for an incoming message.

VOX (unlimited): The unit will record an incoming message as long as the caller talks (pre-selected setting).

1 MIN (1 minute): The unit will record each incoming message up to 1 minute.

- 1 Press **MENU**.
Display: 1. SYSTEM SET UP
- 2 Press **□**, then **1 0**.
RECORDING TIME
- 3 Press **START/COPY/SET**.
MODE=VOX ▼▲
- 4 Press ▼ or ▲ to select the desired setting.
- 5 Press **START/COPY/SET**.
SETUP ITEM []
- 6 Press **MENU**.

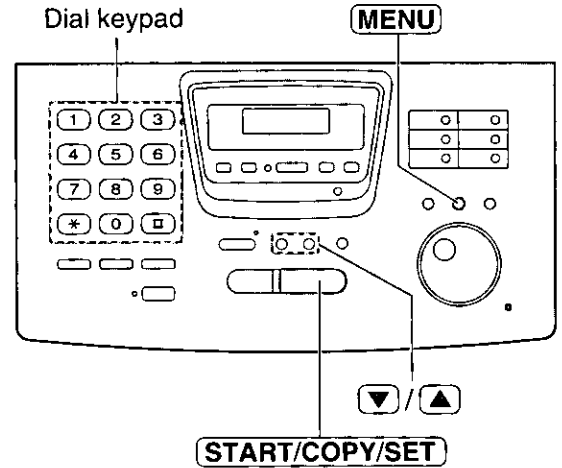

Message alert

(beeps when a voice message is received)

When this feature is on, the unit will let you know with slow beeps that a caller's message has been recorded.

- 1 Press **MENU**.
Display: 1. SYSTEM SET UP
- 2 Press **□**, then **4 2**.
MESSAGE ALERT
- 3 Press **START/COPY/SET**.
MODE=OFF ▼▲
- 4 Press ▼ or ▲ to select "ON".
MODE=ON ▼▲
o If this feature is not required, select "OFF".
- 5 Press **START/COPY/SET**.
SETUP ITEM []
- 6 Press **MENU**.

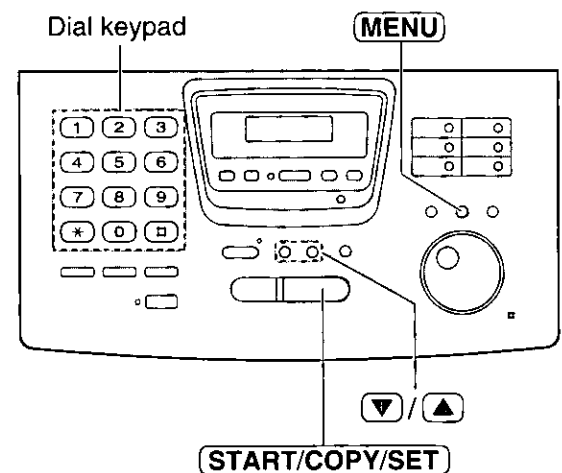

Recording time alert --- ---

(beeps when memory is almost full)

When there is less than 60 seconds of recording time for incoming messages, the unit will alert the user with slow beeps.

- 1 Press **MENU**.
Display: 1. SYSTEM SET UP
- 2 Press **□**, then **4 3**.
REC. TIME ALERT
- 3 Press **START/COPY/SET**.
MODE=OFF ▼▲
- 4 Press ▼ or ▲ to select "ON".
MODE=ON ▼▲
 - If this feature is not required, select "OFF".
- 5 Press **START/COPY/SET**.
SETUP ITEM []
- 6 Press **MENU**.

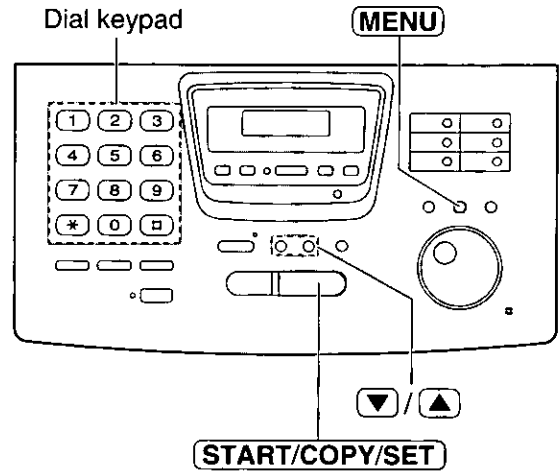

Setting the ICM monitor --- ---

When a call is received with the answering device, the incoming messages will be heard from the speaker during the call. If you do not want the messages to be heard by other persons who share your unit, set this feature to "OFF".

- 1 Press **MENU**.
Display: 1. SYSTEM SET UP
- 2 Press **□**, then **6 7**.
ICM MONITOR
- 3 Press **START/COPY/SET**.
MODE=ON ▼▲
- 4 Press ▼ or ▲ to select "OFF".
MODE=OFF ▼▲
 - If this feature is required, select "ON".
- 5 Press **START/COPY/SET**.
SETUP ITEM []
- 6 Press **MENU**.

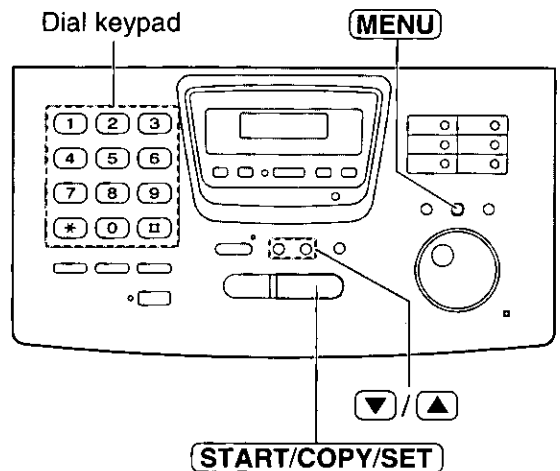

Error Messages

Reports

When your fax does not transmit, check the following items first.

- The number you dialed is correct.
- The other party's machine is a facsimile.

If the problem remains, correct it by following the communication message printed on the sending and journal reports (see pages 62 and 63).

Communication message	Error code	Cause & Remedy
COMMUNICATION ERROR	41–72 FF	o A transmission or reception error occurred. Try again or check with the other party.
DOCUMENT JAMMED	—	o The document is jammed. Remove the jammed document (p. 117).
ERROR-NOT YOUR UNIT	54, 59 70	o A transmission or reception error occurred because of a problem with the other party's fax machine. Check with the other party.
MEMORY FULL	—	o The document was not received due to memory being full.
NO DOCUMENT	—	o The document was not fed into the unit properly. Reinsert the document and try again.
OTHER FAX NOT RESPOND	—	o The other party's fax machine was busy or ran out of recording paper. Try again. o The document was not fed properly. Reinsert the document and try again. o The other party's fax machine rings too many times. To send a fax manually, dial the number, confirm the fax tone, and press START/COPY/SET . o The other party's machine is not a facsimile. Check with the other party. o The number you dialed is not in service.
PRESSED THE STOP KEY	—	o The STOP button was pressed and fax communication was canceled.
THE COVER WAS OPENED	—	o The cover was opened. Close it and try again.
OK	—	o Fax communication was successful.

LCD display

If the unit detects a problem, one or more of the following messages will appear on the display.

Display message	Cause & Remedy
CALL SERVICE	<ul style="list-style-type: none"> There is something wrong with the unit. Contact our service personnel.
CHECK COVER	<ul style="list-style-type: none"> The cover is open. Close it.
CHECK DOCUMENT	<ul style="list-style-type: none"> The document is not fed into the unit properly. Reinsert the document. If misfeeding occurs frequently, clean the document feeder rollers and try again (p. 120). If the problem remains, adjust the feeder pressure (p. 117).
CHECK FILM	<ul style="list-style-type: none"> The film cartridge is not inserted properly. Reinsert it correctly (p. 118, 119).
CHECK LEVER	<ul style="list-style-type: none"> The recording paper set lever is released. Push it back to set the lever (p. 27).
CHECK MEMORY	<ul style="list-style-type: none"> Memory (telephone numbers, parameters, etc.) has been erased. Re-program.
CHECK PAPER	<ul style="list-style-type: none"> The recording paper is not installed or the unit ran out of paper. Install paper (p. 26, 27). The recording paper is not fed into the unit properly or has jammed near the recording paper entrance. Clear the jammed paper (see "When paper has jammed near the recording paper entrance" on page 116). Do not install folded or heavily curled paper in the paper tray.
FAX IN MEMORY	<ul style="list-style-type: none"> The unit has (a) document(s) in memory. See the other message instructions to print out the document(s).
FAX MEMORY FULL	<ul style="list-style-type: none"> Memory is full of received documents due to a lack of recording paper or a recording paper jam, etc. Install paper or clear the jammed paper. When performing memory transmission, the document being stored exceeds the memory capacity of the unit. Transmit the entire document by using manual or automatic transmission.
FILM EMPTY	<ul style="list-style-type: none"> The film is empty. Replace the film or film cartridge with a new one (p. 118, 119). The film is slack. Tighten it (see step 9 on page 119) and install again.
FILM NEAR EMPTY	<ul style="list-style-type: none"> The remaining film can print about 15 pages of letter size documents. Prepare a new film or film cartridge (p. 18).
FREE FILM EMPTY	<ul style="list-style-type: none"> The free starter film is empty. Replace the film or film cartridge with a new one (p. 118, 119).
JOG-DIAL FULL	<ul style="list-style-type: none"> There is no space to store new stations in the JOG DIAL directory. Edit or erase unnecessary stations (p. 42, 43).
LOADING ERROR	<ul style="list-style-type: none"> A loading error occurred while receiving data from FaxSav. Contact FaxSav at 1-888-332-9728.
MESSAGE FULL	<ul style="list-style-type: none"> There is no room left in memory to record a voice message. Erase some or all of the messages (p. 94, 100).

Help



(continued)

Error Messages

Display message	Cause & Remedy
NO FAX REPLY	● The other party's fax machine is busy or ran out of recording paper. Try again.
PAPER JAMMED	● A recording paper jam occurred under the film cartridge. Clear the jammed paper (p. 115).
PLEASE WAIT	● The unit is checking if the film is set correctly. Wait for a while.
REDIAL TIME OUT	● The other party's fax machine is busy or ran out of recording paper. Try again.
REMOVE DOCUMENT	● The document is jammed. Remove the jammed document (p. 117). ● Attempted to transmit a document longer than 600 mm (23 ⁵ / ₈ "). Press the STOP button to remove the document. Divide the document into two or more sheets and try again.
TRANSMIT ERROR	● A transmission error occurred. Try again.
UNIT OVERHEATED	● The unit is too hot. Let the unit cool down.

When a function does not work, check here before requesting help

General

Problem	Cause & Remedy
I cannot make and receive calls.	<ul style="list-style-type: none"> The power cord or telephone line cord is not connected. Check the connections (p. 28).
I cannot make calls.	<ul style="list-style-type: none"> The dialing mode setting is wrong. Change to "TONE" or "PULSE" (p. 37).
The unit does not work.	<ul style="list-style-type: none"> Disconnect the unit from the telephone line and connect the line to a known working telephone. If the working telephone operates properly, contact our service personnel to have the unit repaired. If the working telephone does not operate properly, contact your telephone company.
The unit does not ring.	<ul style="list-style-type: none"> The ringer volume is set to off. Adjust it to a suitable level (p. 33).
The other party complains they only hear a fax tone and cannot talk.	<ul style="list-style-type: none"> The FAX ONLY mode is set. Tell them the number is used for faxes only or change to another mode (p. 70, 71).
The speakerphone is not working.	<ul style="list-style-type: none"> Use the speakerphone in a quiet room. If you have difficulty hearing the other party, adjust the volume using  or . If parts of your conversation are cut off, you and the other party spoke at the same time. Speak alternately.
The REDIAL/PAUSE button does not function properly.	<ul style="list-style-type: none"> If this button is pressed during dialing, a pause will be inserted. If pressed immediately after a dial tone is obtained, the last number dialed will be redialed.
The receive mode does not function as explained on pages 70 and 71.	<ul style="list-style-type: none"> A Distinctive Ringing pattern is set (p. 76, 77). The TEL/FAX mode is set (p. 78 to 81).
During programming, I cannot enter the code or ID number.	<ul style="list-style-type: none"> All or part of their numbers are the same. Change the number (p. 82, 98).
The film runs out quickly.	<ul style="list-style-type: none"> The HELP button, copy function, and reports use more film.

Fax transmission

Problem	Cause & Remedy
I cannot send documents.	<ul style="list-style-type: none"> The other party's fax machine was busy or ran out of paper. Try again. The other party's machine is not a facsimile. Check with the other party. The other party's fax machine rings too many times. Send the fax manually - dial the number, confirm the fax tone, then press START/COPY/SET.

(continued)

Operations

Fax transmission

Problem	Cause & Remedy
The other party complains that letters on their received document are distorted.	<ul style="list-style-type: none"> o If your line has special telephone services such as call waiting, the service may have been activated during fax transmission. Connect the unit to a line that does not have these services. o The extension telephone on the same line is off the hook. Hang up the extension telephone and try again.
The other party complains that dirty patterns or black lines appear on their received documents.	<ul style="list-style-type: none"> o The glass or rollers are dirty. Clean them (p. 120).
I cannot make an international fax call.	<ul style="list-style-type: none"> o Use the overseas transmission mode (p. 68). o Add two pauses at the end of the telephone number (p. 36) or dial manually.



Fax reception

Problem	Cause & Remedy
I cannot receive documents automatically.	<ul style="list-style-type: none"> o The receive mode is set to the TEL mode. Set to the TAD/FAX, FAX ONLY or TEL/FAX mode. o The time to answer the call is too long. Decrease the number of rings (p. 74, 81, 105). o The greeting message is too long. Shorten the message (p. 91).
The display shows "CONNECTING....." but faxes are not received.	<ul style="list-style-type: none"> o The incoming call is not a fax. Change the receive mode.
The recording image is faint.	<ul style="list-style-type: none"> o The sender transmitted a faint document. Ask them to transmit a clearer copy of the document. o The thermal head is dirty. Clean it (p. 120).
The printing quality is poor.	<ul style="list-style-type: none"> o Some paper has instructions recommending which side to print on. Try turning the paper over. We recommend smooth paper such as Hammermill® Jet Print for clearer printing.
A blank sheet is ejected after the received documents are printed out.	<ul style="list-style-type: none"> o The receiving reduction rate is not programmed correctly. Program the proper rate (p. 83).

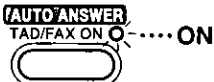
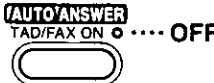
Receive mode

Problem	Cause & Remedy
I cannot select the desired receive mode.	<ul style="list-style-type: none"> o If you set the TAD/FAX, FAX ONLY or TEL/FAX mode: <ul style="list-style-type: none"> - Select the desired mode using feature #77 (p. 73), and - Press AUTO ANSWER to turn on the AUTO ANSWER light.  o If you set the TEL mode: <ul style="list-style-type: none"> - Press AUTO ANSWER to turn off the AUTO ANSWER light. 

Copying

Problem	Cause & Remedy
When you try to make a copy, the unit beeps and the display shows "CHECK PAPER".	<ul style="list-style-type: none"> ● Pull the recording paper set lever forward, make sure the paper is inserted correctly and push the recording paper set lever back.
The unit does not make a copy.	<ul style="list-style-type: none"> ● You cannot make a copy during programming. Try to make a copy after programming or stop the programming.
A dirty pattern or a black line appears on the copied documents.	<ul style="list-style-type: none"> ● The glass or rollers are dirty. Clean them (p. 120).
The copied image is distorted.	<ul style="list-style-type: none"> ● The thermal head is dirty. Clean it (p. 120).
The document is not copied properly.	<ul style="list-style-type: none"> ● The film is not inserted correctly. Insert it correctly (p. 118, 119).
The copied document is blank.	<ul style="list-style-type: none"> ● The film is not inserted correctly. Insert it correctly (p. 118, 119).
The printing quality is poor.	<ul style="list-style-type: none"> ● Some paper has instructions recommending which side to print on. Try turning the paper over. We recommend smooth paper such as Hammermill® Jet Print for clearer printing.
<p>The printing is faint.</p> <p style="text-align: center;">Original</p> <div style="text-align: center;">  </div> <p style="text-align: center;">Copy</p> <div style="text-align: center;">  </div>	<ul style="list-style-type: none"> ● You may have used paper with a cotton and/or fiber content that is over 20%, such as letterhead or resume paper. We recommend smooth paper such as Hammermill® Jet Print for clearer printing.
A paper jam occurs during copying.	<ul style="list-style-type: none"> ● The film is not inserted correctly. Insert it correctly (p. 118, 119).

Answering device

Problem	Cause & Remedy
No voice messages have been recorded in the TAD/FAX mode.	<ul style="list-style-type: none"> ● The memory is full. Erase some or all the messages (p. 94, 100).
I cannot retrieve recorded messages from a remote telephone.	<ul style="list-style-type: none"> ● Make sure that you use the remote operation ID correctly (p. 98).

Operations

If a power failure occurs

- The unit will not function.
- Transmission and reception will be interrupted. Check the transactions by printing a journal report.
- If fax documents are stored in memory, they will be lost. When power is restored, a power-down report will be printed out stating which contents in memory have been erased.
- If delayed transmission is programmed and the start time has passed during a power failure, transmission will be attempted soon after power is restored.

Power down report

The power down report will be automatically printed out after power is restored.
The report will not be printed out when there are not any documents stored in memory.

Sample of a power down report

POWER DOWN REPORT				
			POWER DOWN AT:Jan. 05 1998 04:30AM	
			RESTARTED AT:Jan. 05 1998 04:31AM	
<< WARNING >>				
CONTENTS HAVE BEEN CLEARED DUE TO POWER DOWN.				
FOR ADDITIONAL INFORMATION, PLEASE SEE THE JOURNAL REPORT.				
NO.	OTHER FACSIMILE	MODE	PAGES	FUNCTION
01	<FAX # NOT AVAIL.>	RCV	01	MEMORY RECEIVE

Recording paper jam

If the unit does not eject any recording paper during reception or copying, the recording paper has jammed. Remove the jammed paper by following the display message on this page and page 116.

When paper has jammed under the film cartridge

The display will show the following message.

Display: PAPER JAMMED

Remove the jammed paper as follows.

- 1** Slide the cover open lever forward.
- 2** The cover is under tension to improve print quality. Pull up hard enough to open.
- 3** Remove the film cartridge.
- 4** Remove the jammed recording paper.
- 5** If the film is slack, tighten it by winding the bottom side gears.
- 6** Replace the film cartridge by matching the blue label side of the cartridge with the one on the unit.
- 7** Close the cover securely by pushing down on both ends.

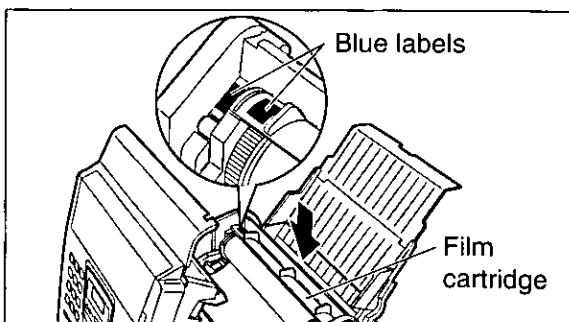
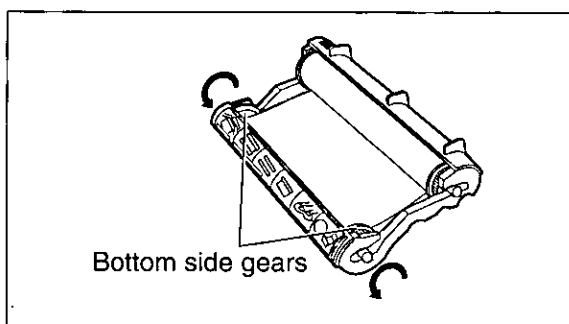
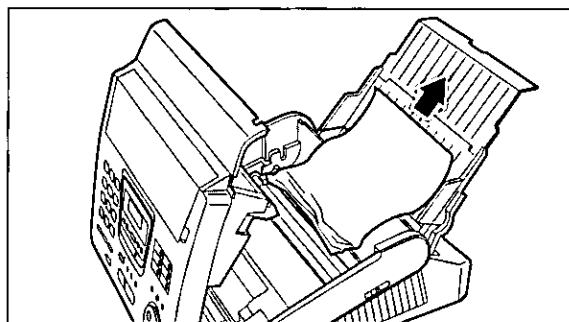
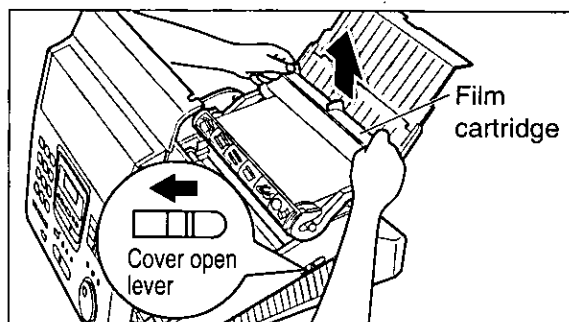

Help

When paper has jammed near the recording paper entrance

The display will show the following message.

Display: CHECK PAPER

Remove the jammed paper as follows.

Pull the recording paper set lever forward, then pull out the jammed recording paper from the recording paper entrance.

Push the set lever back.

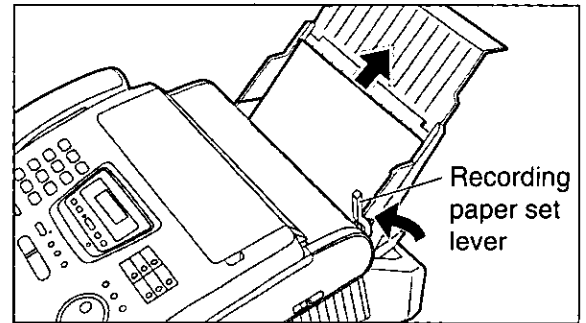

When paper has not been ejected even though "PAPER JAMMED" or "CHECK PAPER" is not displayed

Check the recording paper exit. If there is jammed paper, remove it as follows.

1 First, lift the front of the unit. Pull the paper stacker forward until it stops, then press the center slots to unlock and remove the paper stacker.

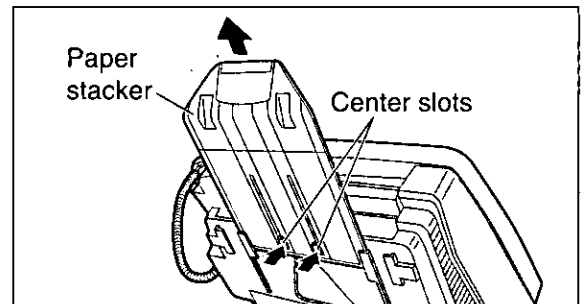

2 Tilt the unit up and push the jammed recording paper out through the triangular window on the bottom of the unit.

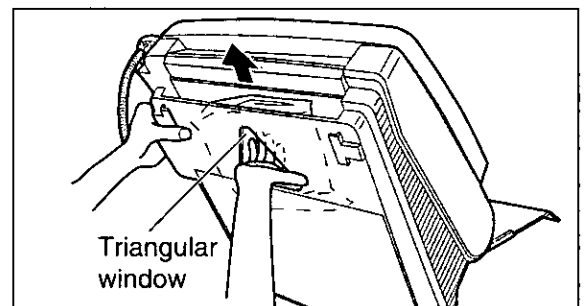

3 Remove the jammed recording paper from the recording paper exit.
• If you cannot remove the jammed paper, remove it by following the instructions on page 115.

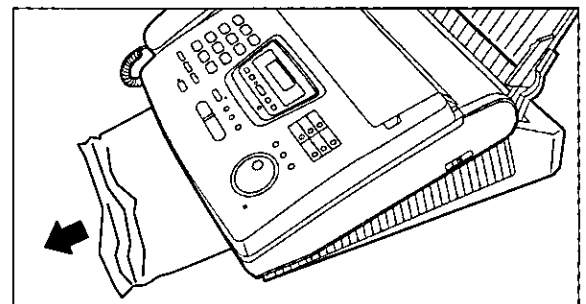

Sending document jams

If the unit does not release the document during feeding, remove the document as follows.

- 1** Slide the cover open lever forward.
- 2** The cover is under tension to improve print quality. Pull up hard enough to open.
- 3** Remove the jammed document carefully.
- 4** Close the cover securely by pushing down on both ends.

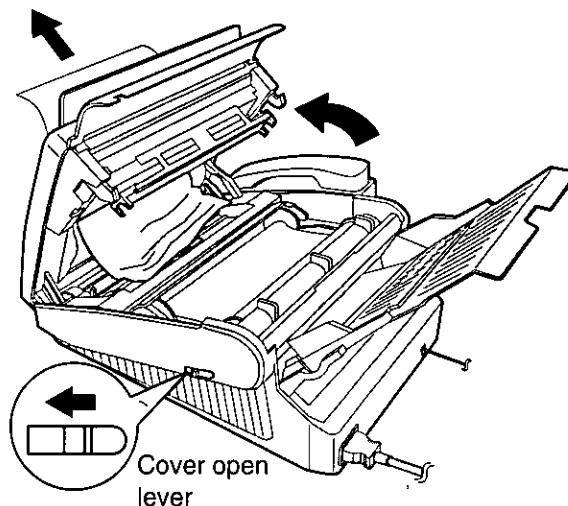

Note:

- Before opening the cover, do not pull out the jammed paper forcibly.

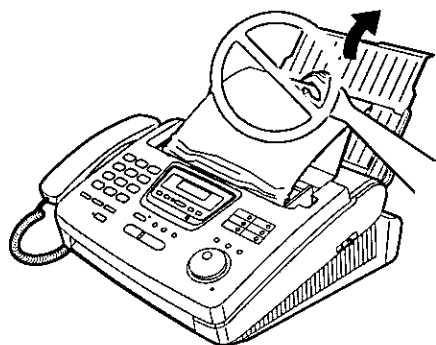

Sending document does not feed, or multi-feeds

If no feeding or multiple feeding occurs frequently, adjust the feeder pressure.

- 1** Slide the cover open lever forward.
- 2** The cover is under tension to improve print quality. Pull up hard enough to open.
- 3** Shift the position of the lever using an instrument with a pointed end, like a paper clip.
 - Position A:** When documents do not feed.
 - Position B:** Standard position (pre-selected)
 - Position C:** When documents multiple feed.
- 4** Close the cover securely by pushing down on both ends.

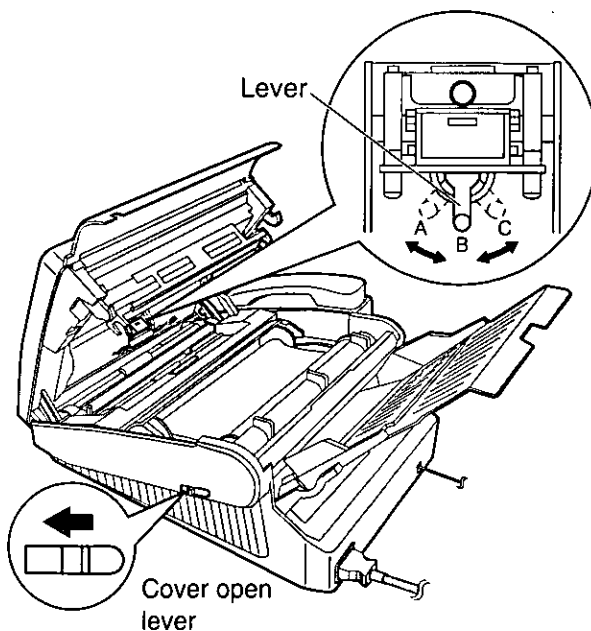

Help

How much film you have left

To check the amount of remaining film, press **FILM REMAINING** while the unit is idle. The display indicates the approximate amount of remaining film.

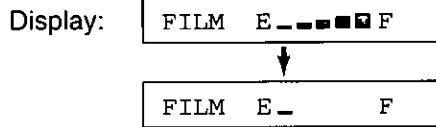

When the film indicator points to this position, the remaining film will print up to 25 pages of letter size documents. Prepare a new film or film cartridge for replacement.

Replacing the film or film cartridge

When the unit detects the end of the film, the following message will be displayed.

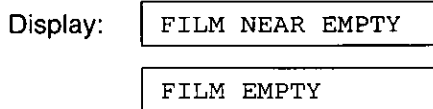

The remaining film prints about 15 pages of letter size documents. Prepare a new film or film cartridge.

The film is empty. Install a new film or film cartridge.

The following replacement kits are available.

KX-FA135: Film cartridge (1 cartridge and 1 film)

KX-FA136: Replacement film (2 films)

To order replacement kits, see page 18.

- 1 Slide the cover open lever forward.
- 2 The cover is under tension to improve print quality. Pull up hard enough to open.
- 3 Remove the film cartridge.
 - If you have purchased a film cartridge (Model no. KX-FA135) for replacement, skip to step 10.
 - To replace only the film, go to step 4.
- 4 Unlock the four gears by (A) pulling the top side gears (blue and green gears) forward and (B) pushing back the bottom side gears (green gears). Remove the used film.

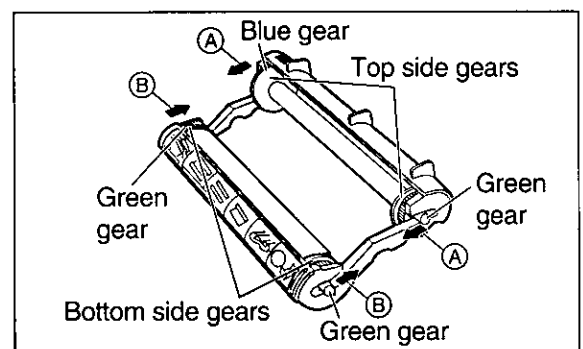
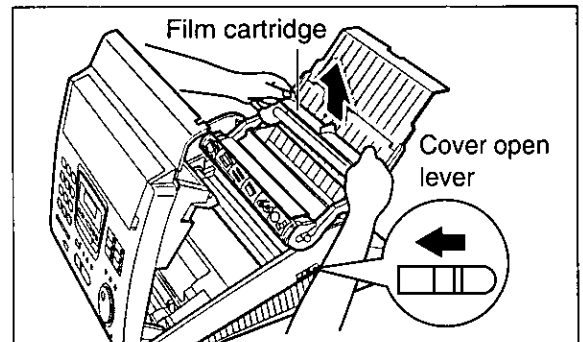

- 5 Remove the four gears from the used film cores.

Caution:

- The film is not reusable. You can order a new film for replacement through your nearest Panasonic dealer or call 1-800-435-7329.

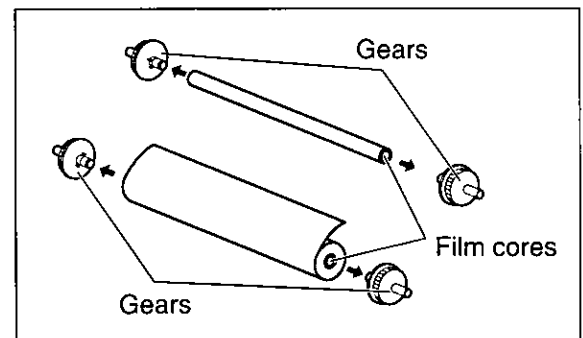

6 Insert the blue gear into the blue core of the new film.

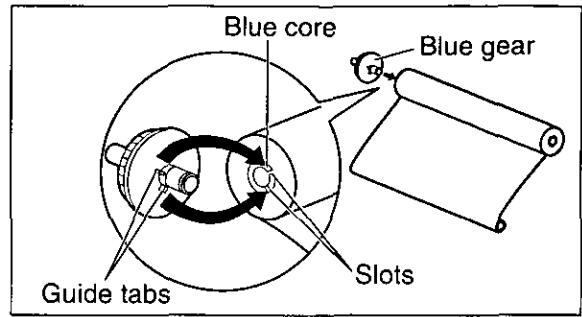

7 Insert the three green gears into the remaining cores of the new film.

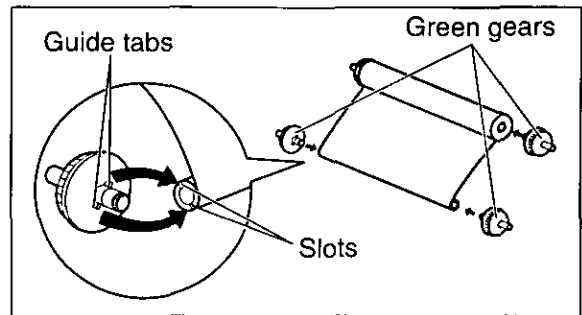

8 Insert the film into the cartridge so that the blue gear matches the blue label on the cartridge.
 • The shiny side should be facing up.

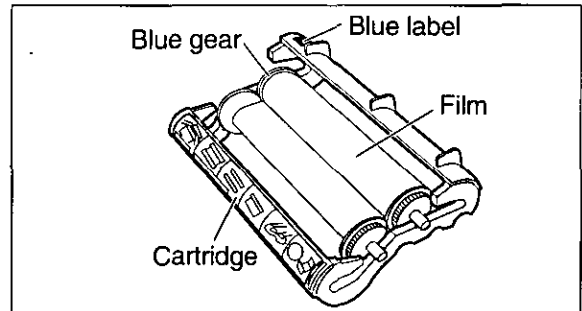

9 Lock the four gears of the film by (A) pushing back the top side gears and (B) pulling the bottom side gears forward until they lock into place.
 • If the film is slack, tighten it by winding the bottom side gears.

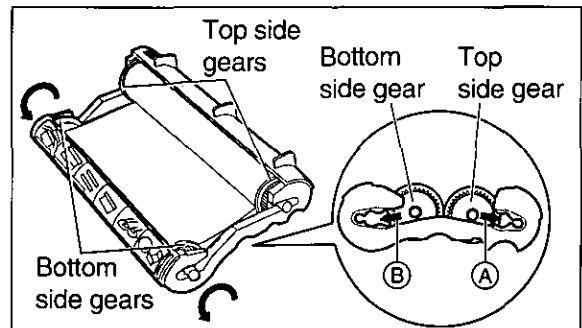
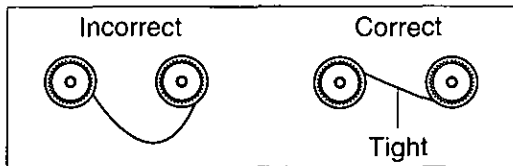

10 Insert the film cartridge by matching the blue label on the cartridge with the one on the unit.

11 Close the cover securely by pushing down on both ends.

• The unit will check if the film is installed correctly. The following message will be displayed.

Display: PLEASE WAIT

• If the following message is displayed, the film is not inserted correctly.

CHECK FILM

Reinsert it correctly.

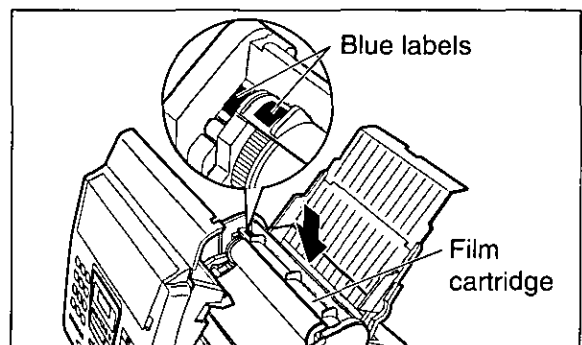

Help

Cleaning

Document feeder

If misfeeding occurs frequently or if dirty patterns or black bands appear on a copied or transmitted document, clean the document feeder.

- 1** Disconnect the power cord and the telephone line cord.
- 2** Slide the cover open lever forward.
- 3** The cover is under tension to improve print quality. Pull up hard enough to open.
- 4** Clean the document feeder rollers, sub roller and rubber flap with a cloth moistened with isopropyl rubbing alcohol, and let all parts dry thoroughly.
- 5** Clean the white plate and glass with a soft dry cloth.
- 6** Close the cover securely by pushing down on both ends.
- 7** Connect the power cord and the telephone line cord.

Caution:

- Do not use paper products, such as paper towels or tissues, to clean the inside of the unit.

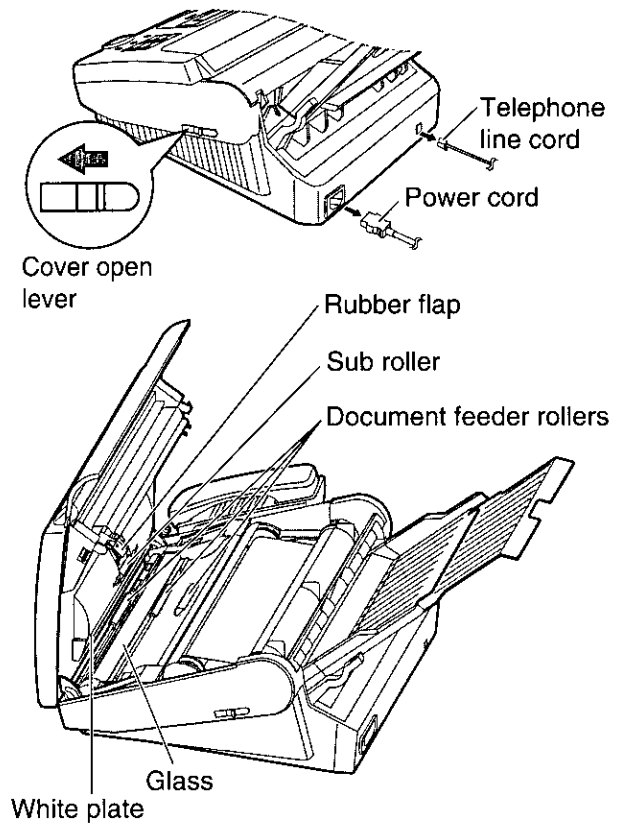

Thermal head and black bar

If dirty patterns or black or white bands appear on a copied or received document, clean the thermal head and black bar.

- 1** Disconnect the power cord and the telephone line cord.
- 2** Slide the cover open lever forward.
- 3** The cover is under tension to improve print quality. Pull up hard enough to open.
- 4** Clean the thermal head and black bar with a cloth moistened with isopropyl rubbing alcohol, and let it dry thoroughly.
- 5** Close the cover securely by pushing down on both ends.
- 6** Connect the power cord and the telephone line cord.

Caution:

- To prevent a malfunction due to static electricity, do not use a dry cloth and do not touch the thermal head directly with your fingers.

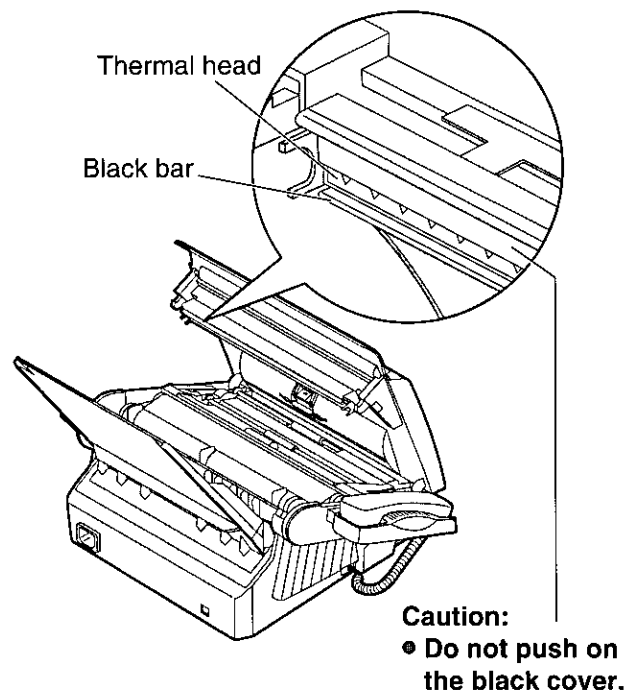

Printing the feature settings, telephone numbers, the journal, printer test list and Caller ID list

You can print out the following documents.

Feature list: provides you with the current settings of the basic and advanced programming features (see pages 140 to 142).

Telephone number list: provides you with names and telephone numbers which are stored in the One-Touch Dial and JOG DIAL directory. The telephone number codes are as shown below.

P: A pause has been entered.

F: A flash has been entered.

[]: A secret telephone number has been entered. (The telephone number is not printed.)

Journal report: keeps records of fax transmissions and receptions. Also, this report will be printed automatically after every 35 fax communications (see page 63).

Printer test list: allows you to check the print quality of your unit. If the test print has a dirty pattern, or blurred points or lines, clean the thermal head (see page 120).

Caller ID list: keeps records of the last 35 callers after subscribing to a Caller ID service. Also, this report will be printed automatically after every 35 callers (see page 52).

1 Press **MENU** two times.
Display: **2 . PRINT REPORT**

2 For the **feature list**, press **□**, then **1**.
SETUP LIST

For the **telephone number list**, press **□**, then **3**.
TEL NO. LIST

For the **journal report**, press **□**, then **4**.
JOURNAL REPORT

For the **printer test list**, press **□**, then **5**.
PRINTER TEST

For the **Caller ID list**, press **□**, then **8**.
CALLER ID LIST

3 Press **START/COPY/SET** to start printing.
PRINTING

- To stop printing, press **STOP**.
- After printing, the following will be displayed.

PRINT ITEM []

4 Press **MENU**.

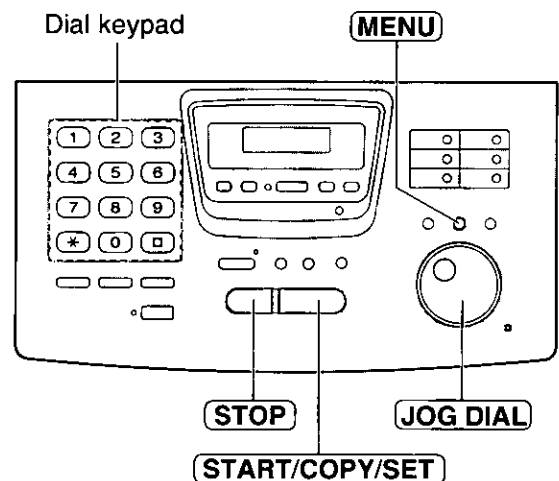

Note:

- In step 2, you can select the desired item by rotating **JOG DIAL**.

Fax voice guidance

You can hear the transmission result by the voice guidance. One of the following messages will be heard if this feature is set to on.

- *Transmission is complete.*
- *Transmission has failed.*
- *Transmission has been interrupted.*

When friendly reception (see page 84) is activated, one of the following messages will also be heard.

- *Please hang up the handset for reception.*
- *Start reception.*

Changing the fax voice guidance setting

One of the following choices is available.

ERROR: The fax voice guidance will be heard only when fax transmission/reception and friendly reception fail.

ON: The voice guidance message regarding fax transmission/reception and friendly reception will be heard after every transaction (pre-selected setting).

OFF: The fax voice guidance will not be heard.

- 1 Press **MENU**.
Display: 1. SYSTEM SET UP
- 2 Press **□**, then **4** **7**.
FAX GUIDANCE
- 3 Press **START/COPY/SET**.
MODE=ON ▼▲
- 4 Press ▼ or ▲ to select the desired setting.
- 5 Press **START/COPY/SET**.
SETUP ITEM [.]
- 6 Press **MENU**.

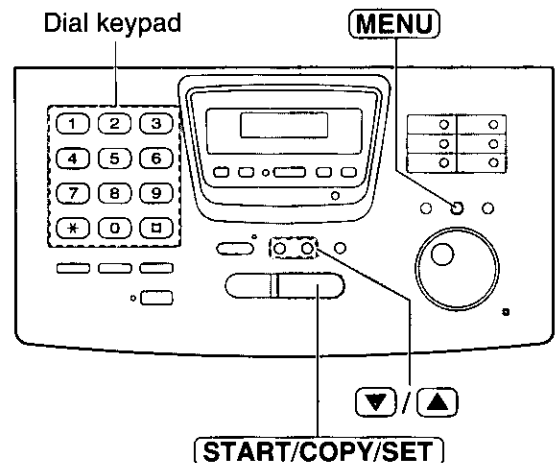

Changing the LCD display contrast

Use this feature to adjust the display contrast.

NORMAL: (Pre-selected setting)

DARKER: Used when the display contrast is too light.

- 1 Press **MENU**.
Display: 1.SYSTEM SET UP
- 2 Press **□**, then **3** **9**.
LCD CONTRAST
- 3 Press **START/COPY/SET**.
MODE=NORMAL ▼▲
- 4 Press ▼ or ▲ to select the desired setting.
- 5 Press **START/COPY/SET**.
SETUP ITEM []
- 6 Press **MENU**.

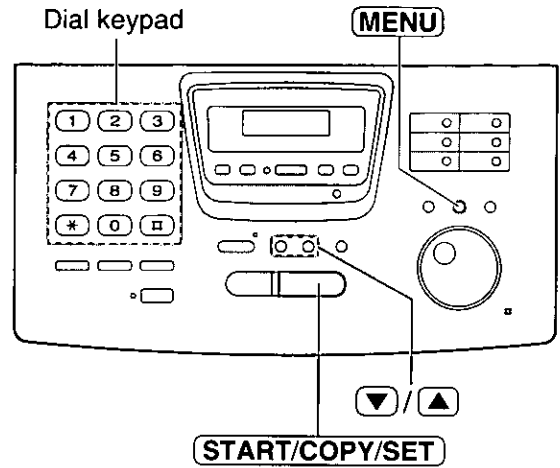

Resetting the advanced features

Use this feature to return the advanced features (see pages 141 and 142) to their pre-selected settings.

- 1 Press **MENU**.
Display: 1.SYSTEM SET UP
- 2 Press **□**, then **8** **0**.
SET DEFAULT
- 3 Press **START/COPY/SET**.
RESET=NO ▼▲
- 4 Press ▼ or ▲ to select "YES".
RESET=YES ▼▲
- 5 Press **START/COPY/SET**.
RESET OK?
- If this feature is not required, press **STOP**.
- 6 Press **START/COPY/SET** again for confirmation.
RESET COMPLETED
↓
SETUP ITEM []
- 7 Press **MENU**.

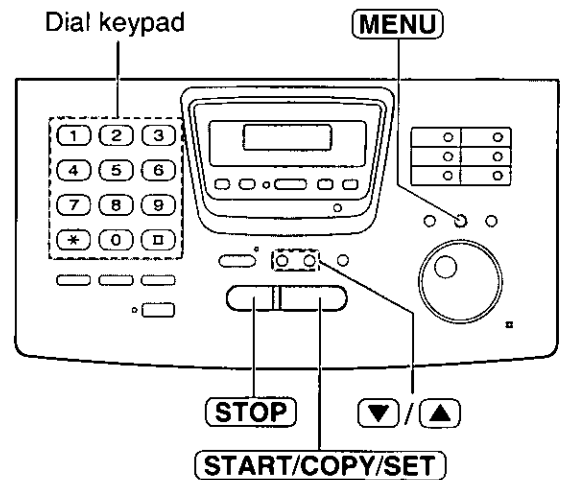

List of FCC requirements and information

If required by the telephone company, inform them of the following.

- FCC Registration No.:
(found on the bottom of the unit)
- Ringer Equivalence No.:
(found on the bottom of the unit)
- The particular telephone line to which the equipment is connected.

This unit must not be connected to a coin operated line. If you are on a party line, check with your local telephone company.

Ringer Equivalence Number (REN):

This REN is useful in determining the quantity of devices you may connect to your telephone line and still have all of those devices ring when your telephone number is called. In most but not all areas, the sum of the REN's of all devices connected to one line should not exceed five (5.0). To be certain of the number of devices you may connect to your line, as determined by the REN, you should contact your local telephone company to determine the maximum REN for your calling area.

In the event that terminal equipment causes harm to the telephone network, the telephone company should notify the customer, if possible, that service may be stopped. However, where prior notice is impractical, the company may temporarily cease service providing that they:

- a) Promptly notify the customer.
- b) Give the customer an opportunity to correct the problem with their equipment.
- c) Inform the customer of the right to bring a complaint to the Federal Communication Commission pursuant to procedures set out in FCC Rules and Regulations Subpart E of Part 68.

The Telephone Company may make changes in its communications facilities, equipment operations, or procedures where such action is reasonably required in the operation of its business and is not inconsistent with the rules and regulations in FCC Part 68. If such changes can be reasonably expected to render any customer terminal equipment incompatible with telephone company communications facilities, or require modification or

alteration of such terminal equipment, or otherwise materially affect its use or performance, the customer shall be given adequate notice in writing, to allow the customer an opportunity to maintain uninterrupted service.

CAUTION:

Any changes or modifications not expressly approved by the party responsible for compliance could void the user's authority to operate this device.

When programming emergency numbers and/or making test calls to emergency numbers:

1. Remain on the line and briefly explain to the dispatcher the reason for the call before hanging up.
2. Perform such activities in the off-peak hours; such as early morning or late evenings.

This telephone provides magnetic coupling to hearing aids.

NOTE:

This equipment has been tested and found to comply with the limits for a Class B digital device, pursuant to Part 15 of the FCC Rules. These limits are designed to provide reasonable protection against harmful interference in a residential installation. This equipment generates, uses, and can radiate radio frequency energy and, if not installed and used in accordance with the instructions, may cause harmful interference to radio communications. However, there is no guarantee that interference will not occur in a particular installation. If this equipment does cause harmful interference to radio or television reception, which can be determined by turning the equipment off and on, the user is encouraged to try to correct the interference by one or more of the following measures:

- Reorient or relocate the receiving antenna.
- Increase the separation between the equipment and receiver.
- Connect the equipment into an outlet on a circuit different from that to which the receiver is connected.
- Consult the dealer or an experienced radio/TV technician for help.

Panasonic Consumer Electronics Company,
Division of Matsushita Electric Corporation of America
One Panasonic Way, Secaucus,
New Jersey 07094

Panasonic Sales Company
Division of Matsushita Electric of
Puerto Rico, Inc.
Ave. 65 de Infantería, Km. 9.5, San Gabriel
Industrial Park, Carolina, Puerto Rico 00985

PANASONIC Facsimile Products Limited Warranty

Panasonic Consumer Electronics Company or Panasonic Sales Company (collectively referred to as "the warrantor"), will repair this product with new or refurbished parts, free of charge, in the USA or Puerto Rico for one (1) year from the date of original purchase in the event of a defect in materials or workmanship.

This Limited Warranty Excludes both Labor and Parts for: batteries, antennas, and cosmetic parts (cabinet).

Carry-in or mail-in service in the USA or Puerto Rico can be obtained during the warranty period by contacting a Panasonic Services Company (PASC) Factory Servicenter listed in the Servicenter Directory. Or call, toll free, 1-800-HELP FAX (1-800-435-7329) to locate a PASC Factory Servicenter. Carry-in or mail-in service in Puerto Rico can be obtained during the warranty period by calling the Panasonic Sales Company telephone number listed in the Servicenter Directory.

This warranty is extended only to the original purchaser. A purchase receipt or other proof of date of original purchase will be required before warranty service is rendered.

This warranty only covers failures due to defects in material or workmanship which occur during normal use and (when applicable) does not cover the print and ink cartridge, the toner cartridge and drum unit or the film cartridge. The warranty does not cover damages which occur in shipment, or failures which are caused by products not supplied by the warrantor, or failures which result from accident, misuse, abuse, neglect, mishandling, faulty installation, misapplication, set-up adjustments, improper operation or maintenance, alteration, modification, power line surge, improper voltage supply, lightning damage, signal reception problems, commercial use such as hotel, office, restaurant, or other business or rental use of the product, or service by anyone other than a PASC Factory Servicenter or a PASC authorized Servicenter, or damage that is attributable to acts of God.

LIMITS AND EXCLUSIONS

There are no express warranties except as listed above.

THE WARRANTOR SHALL NOT BE LIABLE FOR INCIDENTAL OR CONSEQUENTIAL DAMAGES RESULTING FROM THE USE OF THIS PRODUCT, OR ARISING OUT OF ANY BREACH OF THIS WARRANTY. ALL EXPRESS AND IMPLIED WARRANTIES, INCLUDING THE WARRANTIES OF MERCHANTABILITY, ARE LIMITED TO THE APPLICABLE WARRANTY PERIOD SET FORTH ABOVE.

Some states do not allow the exclusion or limitation of incidental or consequential damages, or limitations on how long an implied warranty lasts, so the above exclusions or limitations may not apply to you.

This warranty gives you specific legal rights and you may also have other rights which vary from state to state. If a problem with this product develops during or after the warranty period, you may contact your dealer or Servicenter. If the problem is not handled to your satisfaction, then write to the Customer Satisfaction Center at the company address indicated above.

Warranty

Servicenter Directory

For Product Information, Operating Assistance, Literature Requests, Dealer Locations, and all Customer Service inquiries please contact:
1-800-HELP-FAX (435-7329), Monday-Friday 9am - 8pm EST.

Web Site: <http://www.Panasonic.com>
You can purchase parts, accessories or locate your nearest servicenter by visiting our Web Site.

Factory Servicenters Locations

CALIFORNIA 6550 Katella Avenue Cypress, CA 90630 800 Dubuque Avenue S. San Francisco, CA 94080 20201 Sherman Way Suite 102 Canoga Park, CA 91306 3878 Ruffin Road Suite A San Diego, CA 92123	GEORGIA 8655 Roswell Road Suite 100 Atlanta, GA 30350 ILLINOIS 9060 Golf Road Niles, IL 60714 1703 North Randall Road Elgin, IL 60123 (Pick-up / Drop-off only)	MICHIGAN 37048 Van Dyke Avenue Sterling Heights, MI 48312 MINNESOTA 7850-12 th Avenue South Airport Business Center Bloomington, MN 55425 OHIO 2236 Waycross Road Civic Center Plaza Forest Park, OH 45240	TENNESSEE 3800 Ezell Road Suite 806 Nashville, TN 37211 TEXAS 7482 Harwin Drive Houston, TX 77036 13615 Welch Road Suite #101 Farmers Branch, TX 75244
COLORADO 1640 South Abilene Street Suite D Aurora, CO 80012 FLORIDA 3700 North 29 th Avenue Suite 102 Hollywood, FL 33020	MARYLAND 62 Mountain Road Glen Burnie, MD 21061 MASSACHUSETTS 60 Glacier Drive Suite G Westwood, MA 02090	PENNSYLVANIA 2221 Cabot Blvd. West Suite B Langhorne, PA 19047 Chartiers Valley Shopping Center 1025 Washington Pike Bridgeville, PA 15017	WASHINGTON 20425-84 th Avenue South Kent, WA 98032 HAWAII 99-859 Iwaiwa Street Aiea, Hawaii 96701 Phone (808) 488-1996 Fax (808) 486-4369

Service in Puerto Rico

Matsushita Electric of Puerto Rico, Inc. Panasonic Sales Company/ Factory Servicenter:
Ave. 65 de Infantería, Km. 9.5, San Gabriel Industrial Park, Carolina, Puerto Rico 00985
Phone (787) 750-4300 Fax (787) 763-2910

Accessory Purchases:

Customer Orders Only 1-800-HELP-FAX (435-7329)

As of Mar. '98

Notes for product service and shipping the product

For product service

- Servicers are listed on page 126.
- Call toll free 1-800-HELP-FAX (435-7329) for the location of an authorized servicer.

When you ship the product

- Carefully pack your unit, preferably in the original carton.
- Attach a letter, detailing the symptom or problem, to the outside of the carton.
- Send the unit to an authorized servicer, prepaid and adequately insured.
- Do not send your unit to the Panasonic Consumer Electronics Company or to any executive or regional sales offices. These locations do not repair consumer products.

Specifications

Technical data about this product

Applicable Lines:	Public Switched Telephone Network
Document Size:	Max. 216 mm (8½") in width Max. 600 mm (23⅝") in length
Effective Scanning Width:	208 mm (8⅜")
Recording Paper Size:	Letter: 216 mm × 279 mm (8½"×11") Legal: 216 mm × 356 mm (8½"×14")
Effective Printing Width:	208 mm (8⅜")
Transmission Time*:	Approx. 9 s/page (Original mode)** Approx. 15 s/page (Original mode)** Approx. 30 s/page (G3 Normal mode)
Scanning Density:	Horizontal: 8 pels/mm (203 pels/inch) Vertical: 3.85 lines/mm (98 lines/inch) —STANDARD mode 7.7 lines/mm (196 lines/inch) —FINE/HALF TONE mode 15.4 lines/mm (392 lines/inch) —SUPER FINE mode
Halftone Level:	64-level
Scanner Type:	CCD image sensor
Printer Type:	Thermal Printing
Data Compression System:	Modified Huffman (MH), Modified READ (MR)
Modem Speed:	14,400 / 12,000 / 9,600 / 7,200 / 4,800 / 2,400 bps; Automatic Fallback
Operating Environment:	5 °C – 35 °C (41 °F – 95 °F), 20 % – 80 % RH (Relative Humidity)
Dimensions (H×W×D):	154 mm × 365 mm × 355 mm (6⅛" × 14⅜" × 13⅓")
Mass (Weight):	Approx. 4.85 kg (10.7 lb.)
Power Consumption:	Standby: Approx. 6.0 W Transmission: Approx. 14 W Reception: Approx. 37 W (When receiving a 20% black document) Copy: Approx. 48 W (When copying a 20% black document) Maximum: Approx. 160 W (When copying a 100% black document)
Power Supply:	120 V AC, 60 Hz (This unit will not function at 50 Hz.)
Memory Capacity:	Voice memory: Approx. 18 minutes of recording time including the greeting message**** Fax memory: Approx. 28 pages of memory reception Approx. 25 pages of memory transmission (Based on the CCITT No. 1 Test Chart in standard resolution.)

* Transmission speed depends upon the contents of the pages, resolution, telephone line conditions and capability of the receiving unit.

** The 9 second speed is based upon the CCITT No. 1 Test Chart on the condition that memory transmission is performed.

*** The 15 second speed is based upon the CCITT No. 1 Test Chart.

**** Recording time may be reduced by the calling party's background noise.

Note:

- Any details given in these instructions are subject to change without notice.
- The pictures and illustrations in these instructions may vary slightly from the actual product.

CCITT No. 1 Test Chart

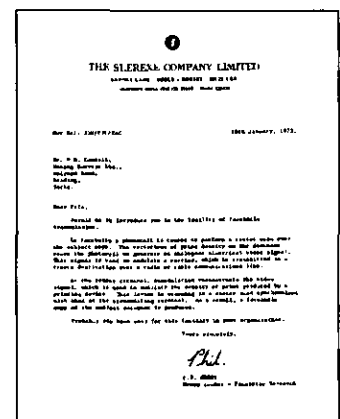

Instalación

Quite la cinta de transporte de la unidad y del apilador de papel y haga la instalación de la forma siguiente.

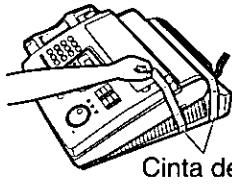

Cinta de transporte

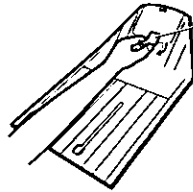

Cinta de transporte

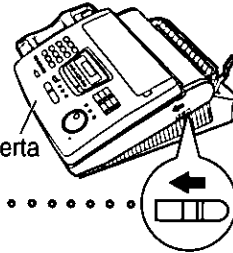

Cubierta

Palanca de apertura de la cubierta

1 Cartucho de película

- Deslice hacia adelante la palanca de apertura de la cubierta.
- La cubierta está bajo tensión para mejorar la calidad de la impresión. Tire hacia arriba con fuerza suficiente para abrirla.
- Quite la hoja de la unidad.
- Si la película está floja en su cartucho, ténsela girando los engranajes del lado inferior.

Incorrecto



Correcto



Tensa

- Instale el cartucho de película en el interior de la unidad.
- Asegúrese de que la etiqueta azul del cartucho concuerde con la de la unidad.
- Cierre firmemente la cubierta empujando hacia abajo sobre ambas esquinas.

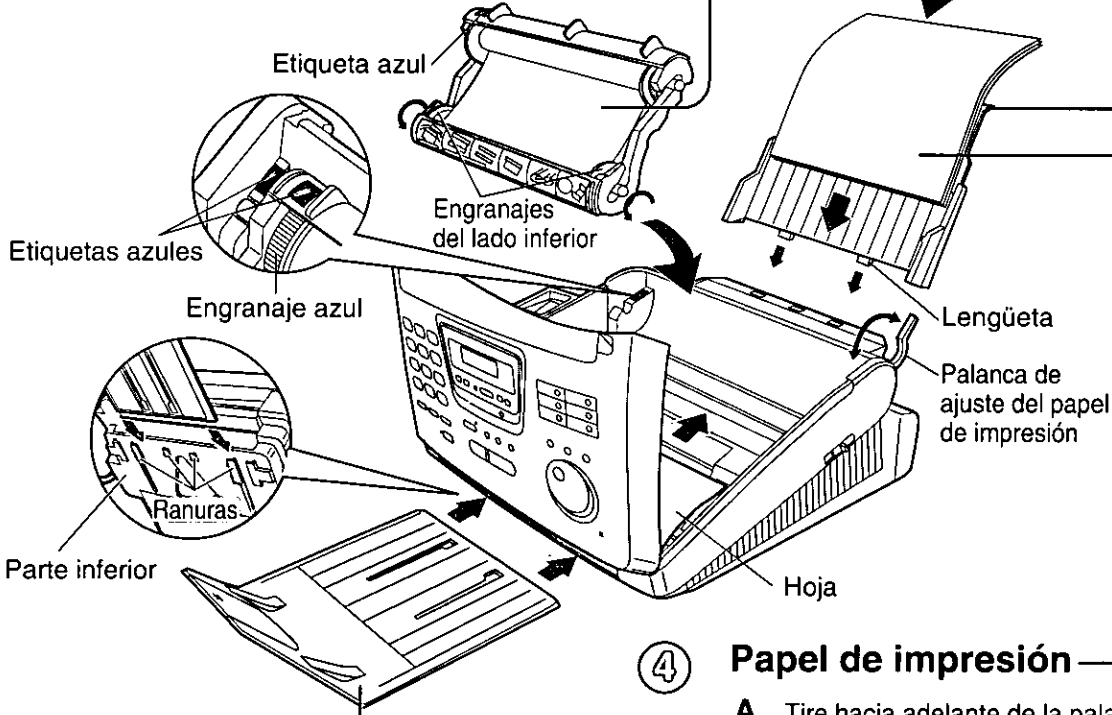

3 Bandeja de papel

- Abra la bandeja de papel.
- Inserte las dos lengüetas de la bandeja de papel en las ranuras de la parte trasera de la unidad.



4 Papel de impresión

- Tire hacia adelante de la palanca de ajuste del papel de impresión.
- Separe el papel para evitar que se atasque e insértelo en el interior de la bandeja de papel.
- Mueva hacia atrás la palanca de ajuste del papel de impresión.

2 Apilador de papel

- Levante la parte delantera de la unidad, inserte el apilador de papel en las ranuras y deslícelo hasta que se pare.

Conexiones

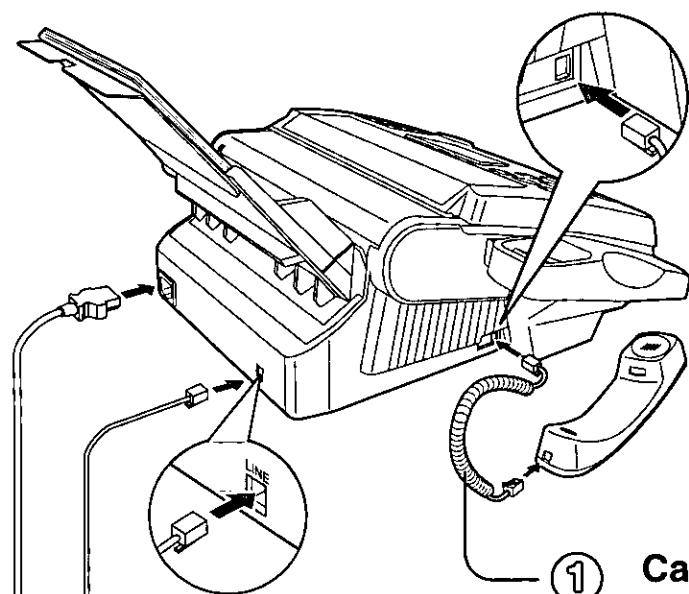

- ① **Cable del auricular**
A. Conéctelo a la unidad.
B. Conéctelo al auricular.

- ② **Cable de línea telefónica**
A. Conéctelo a "LINE" de la unidad.
B. Conéctelo a una toma de línea telefónica sencilla.

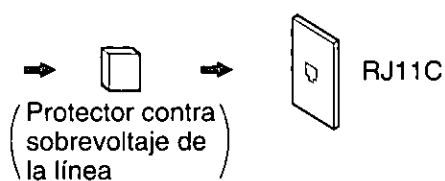

- ③ **Cable de electricidad**
A. Conéctelo a la unidad.
B. Conéctelo a una toma de corriente.

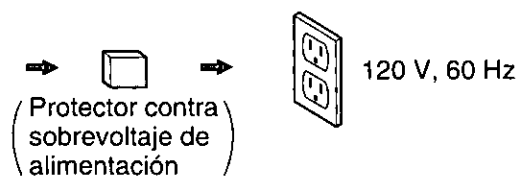

Programación inicial

Ajuste de la fecha y la hora

- ① Pulse **MENU**.
- ② Pulse **☐**, y luego **0 1**.
- ③ Pulse **START/COPY/SET**.
- ④ Introduzca el mes/día/año correcto seleccionándolos con 2 dígitos para cada uno utilizando el teclado de marcación o **JOG DIAL**. Si utiliza **JOG DIAL**, pulse **▶** para mover el cursor.
- ⑤ Pulse **START/COPY/SET**.
- ⑥ Introduzca la hora/minuto correcto seleccionando cada uno de ellos mediante 2 dígitos con el teclado de marcación o **JOG DIAL**. Si utiliza **JOG DIAL**, pulse **▶** para mover el cursor.
Pulse ***** para seleccionar "AM" o "PM".
- ⑦ Pulse **START/COPY/SET**.
- ⑧ Pulse **MENU**.

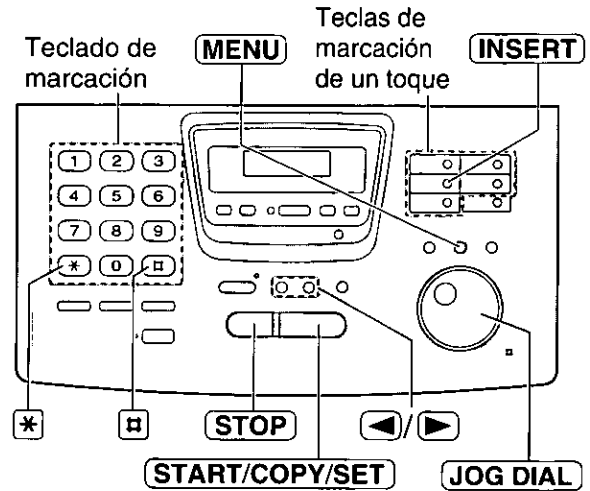

Ajuste de su logotipo

- ① Pulse **MENU**.
- ② Pulse **☐**, y luego **0 2**.
- ③ Pulse **START/COPY/SET**.
- ④ Introduzca su logotipo, con un máximo de 30 caracteres, utilizando el teclado de marcación (consulte las instrucciones de la derecha) o **JOG DIAL** (consulte la página siguiente).
• Para introducir continuamente el mismo número, pulse **▶** para mover el cursor al siguiente espacio.
- ⑤ Pulse **START/COPY/SET**.
- ⑥ Pulse **MENU**.

Ajuste del número de teléfono de su facsímil

- ① Pulse **MENU**.
- ② Pulse **☐**, y luego **0 3**.
- ③ Pulse **START/COPY/SET**.
- ④ Introduzca el número de teléfono de su facsímil con un máximo de 20 dígitos utilizando el teclado de marcación o **JOG DIAL**. Si utiliza **JOG DIAL**, pulse **▶** para mover el cursor.
• El botón **☐** reemplaza un carácter por un espacio y el botón ***** reemplaza un carácter por un signo "+".
- ⑤ Pulse **START/COPY/SET**.
- ⑥ Pulse **MENU**.

Selección de caracteres con el teclado de marcación

Teclas	Caracteres
Teclas de marcación	1 [] { } + - / =
	, . _ ' : ; ?
	2 A B C a b c 2
	3 D E F d e f 3
	4 G H I g h i 4
	5 J K L j k l 5
	6 M N O m n o 6
	7 P Q R S p q r s 7
	8 T U V t u v 8
	9 W X Y Z w x y z 9
0	0 () < > ! " # \$
	% & ¥ * @ ^ ' →
Teclado de marcación de un toque	Tecla INSERT (Se utiliza para insertar un carácter o un espacio.)

Para corregir un error

- Pulse **◀** o **▶** para mover el cursor al carácter incorrecto, y luego haga la corrección.
- Para borrar un carácter, mueva el cursor al carácter que desee borrar y pulse **STOP** para las características número #02 y #03.

Memorización de nombres y números de teléfono para la marcación de un toque

- ① Pulse **DIRECTORY PROGRAM**.
- ② **Para las estaciones 1-5**
Pulse una de las teclas de marcación de un toque.
 - Si selecciona la tecla de marcación de un toque 1, seleccione "DIAL MODE" pulsando **(▼)**, y luego pulse **START/COPY/SET** para ir a la siguiente indicación.**Para las estaciones 6-10**
Pulse **LOWER**, y luego pulse una de las teclas de marcación de un toque.
- ③ Introduzca el nombre de la estación, un máximo de 10 caracteres, utilizando el teclado de marcación (consulte la página 131) o **JOG DIAL** (consulte abajo).
- ④ Pulse **START/COPY/SET**.
- ⑤ Introduzca el número de teléfono, un máximo de 30 dígitos.
- ⑥ Pulse **START/COPY/SET**.
- ⑦ Pulse **DIRECTORY PROGRAM** para salir de la programación.

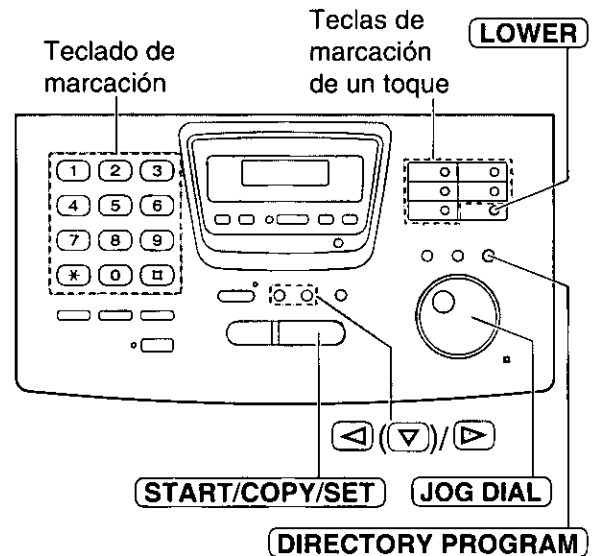

Selección de caracteres con JOG DIAL

En lugar de pulsar las teclas de marcación podrá seleccionar caracteres utilizando JOG DIAL.

1. Gire **JOG DIAL** hasta que se visualice el carácter deseado.
2. Pulse **(▶)** para mover el cursor al siguiente espacio.
 - Se inserta el carácter visualizado en el paso 1.
3. Vuelva al paso 1 para introducir el siguiente carácter.

Orden de visualización de los caracteres

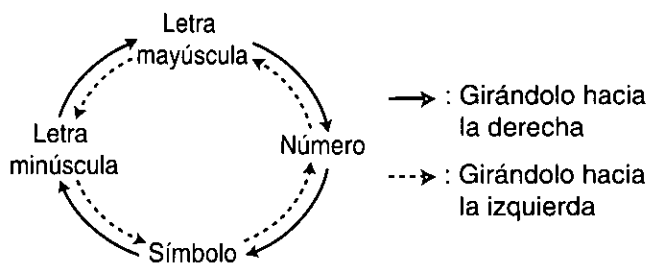

Memorización de nombres y números de teléfono en el directorio JOG DIAL

Para acceder rápidamente a los números marcados frecuentemente, además de la marcación de un toque, la unidad proporciona también el directorio JOG DIAL (100 estaciones para el KX-FP270, 60 estaciones para el KX-FP265).

- ① Pulse **DIRECTORY PROGRAM**.
- ② Gire **JOG DIAL** e introduzca el nombre, hasta 10 caracteres, utilizando el teclado de marcación (consulte la página 131) o **JOG DIAL** (consulte la página 132).
- ③ Pulse **START/COPY/SET**.
- ④ Introduzca el número de teléfono, un máximo de 30 dígitos.
- ⑤ Pulse **START/COPY/SET**.
- ⑥ Pulse **DIRECTORY PROGRAM** para salir de la programación.

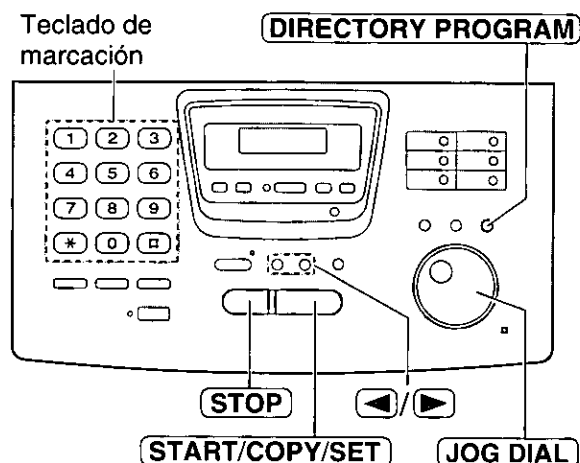

Para corregir un error

- Pulse ◀ o ▶ para mover el cursor al carácter incorrecto, y luego haga la corrección.

Para borrar un carácter

- Mueva el cursor al carácter que desee borrar y pulse **STOP**.

Para hacer/contestar una llamada de voz

■ Para hacer manualmente una llamada de voz

- 1 Levante el auricular.
- 2 Marque el número.
- 3 Cuelgue el auricular cuando termine.

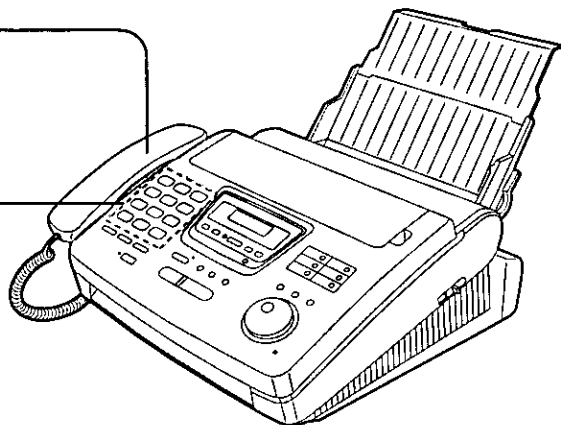

■ Para hacer una llamada de voz utilizando la marcación de un toque

- 1 Levante el auricular.
- 2 **Para las estaciones 1–5**
Pulse la tecla de marcación de un toque deseada.
Para las estaciones 6–10
Pulse **LOWER**, y luego pulse la tecla de marcación de un toque deseada.
- 3 Cuelgue el auricular cuando termine.

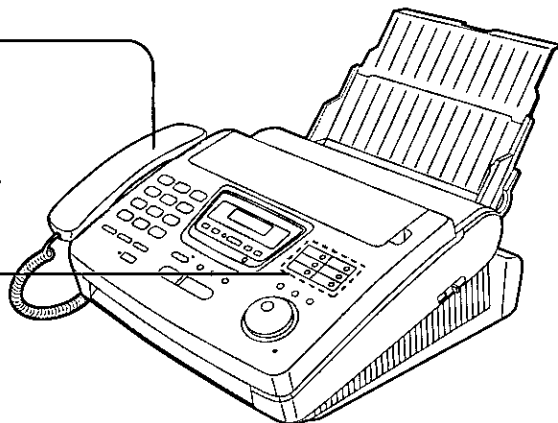

■ Para hacer una llamada de voz utilizando el directorio JOG DIAL

- 1 Gire **JOG DIAL** hasta que se visualice el nombre deseado.
- 2 Levante el auricular.
 - o La unidad empezará a marcar automáticamente.
- 3 Cuelgue el auricular cuando termine.

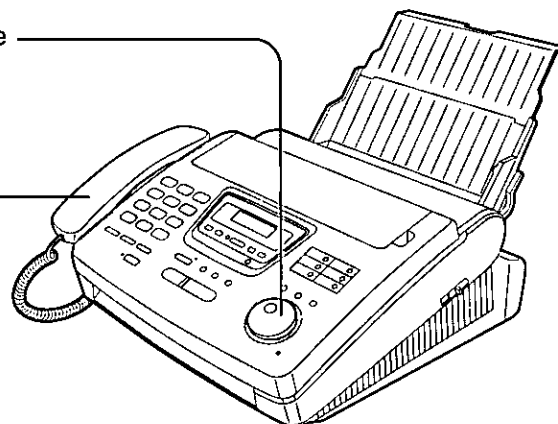

■ Para contestar una llamada de voz

- 1 Levante el auricular cuando oiga el timbre de la unidad.
- 2 Cuelgue el auricular cuando termine.

Envío de un fax

■ Envío manual de un fax

- 1 Abra la bandeja del alimentador de documentos.
- 2 Ajuste la anchura de las guías de documentos según el tamaño del documento.
- 3 Inserte el documento hasta que se oiga un pitido.
- 4 Pulse **DIGITAL SP-PHONE**.
- 5 Marque el número del fax.
- 6 Pulse **START/COPY/SET** cuando oiga el tono del fax.

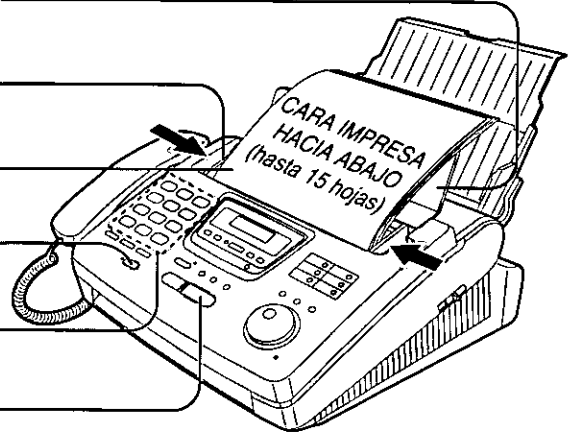

■ Envío de un fax utilizando la marcación de un toque

- 1 Abra la bandeja del alimentador de documentos.
- 2 Ajuste la anchura de las guías de documentos según el tamaño del documento.
- 3 Inserte el documento hasta que se oiga un pitido.
- 4 **Para las estaciones 1-5**
Pulse la tecla de marcación de un toque deseada.
Para las estaciones 6-10
Pulse **LOWER**, y luego pulse la tecla de marcación de un toque deseada.

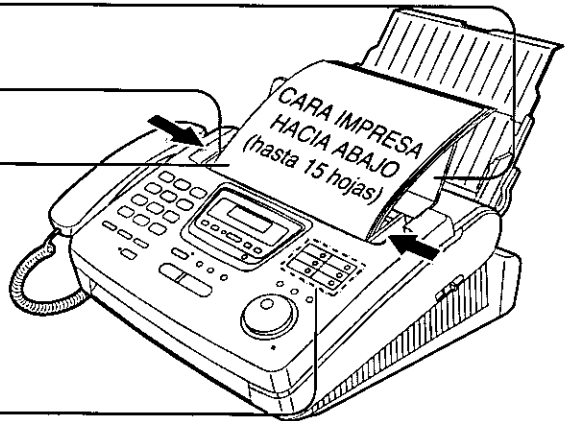

■ Envío de un fax utilizando el directorio JOG DIAL

- 1 Abra la bandeja del alimentador de documentos.
- 2 Ajuste la anchura de las guías de documentos según el tamaño del documento.
- 3 Inserte el documento hasta que se oiga un pitido.
- 4 Gire **JOG DIAL** hasta que se visualice el nombre deseado.
- 5 Pulse **START/COPY/SET**.

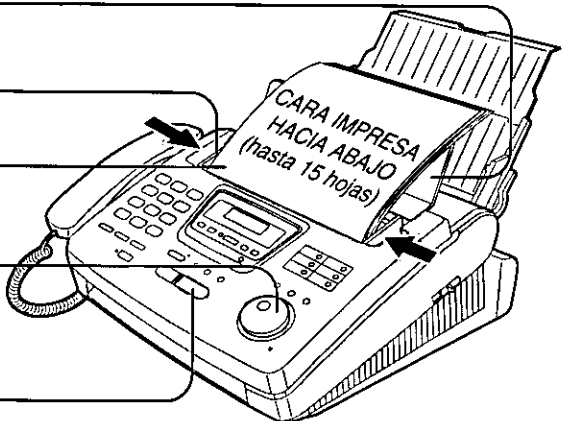

Reciviendo un fax

■ Recepción manual de un fax

- 1 Levante el auricular cuando oiga el timbre de la unidad.
- 2 Cuando:
 - sea necesario recibir un documento,
 - se oiga un tono de llamada de fax (pitido lento), o
 - no se oiga sonido,pulse **START/COPY/SET**.
- 3 Cuelgue el auricular.

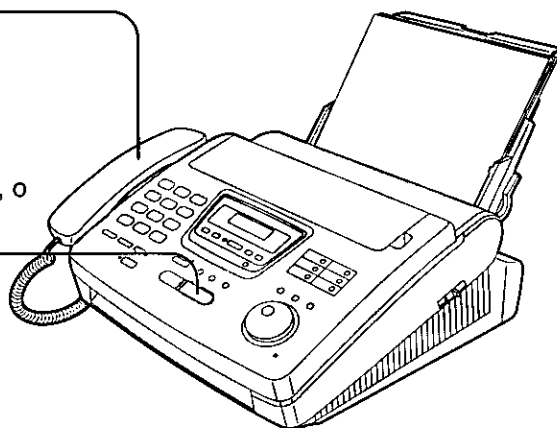

■ Recepción automática de un fax

- 1 Ponga la unidad en el modo AUTO ANSWER pulsando **AUTO ANSWER** hasta que se encienda el indicador AUTO ANSWER.

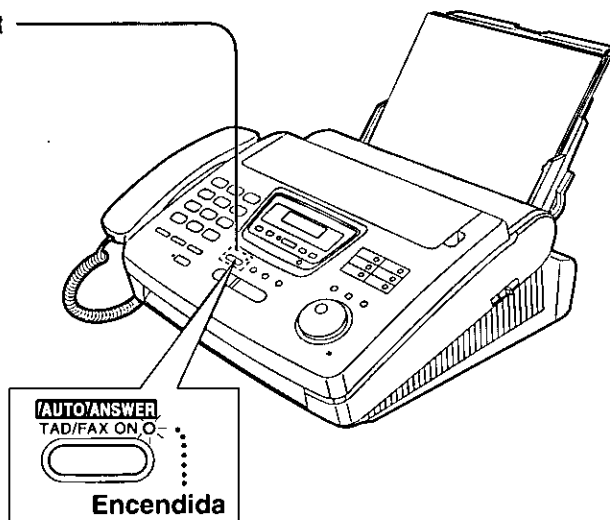

Para hacer una copia

- 1 Abra la bandeja del alimentador de documentos.
- 2 Ajuste la anchura de las guías de documentos según el tamaño del documento.
- 3 Inserte el documento hasta que se oiga un pitido.
- 4 Pulse **START/COPY/SET**.
- 5 Introduzca el número de copias (hasta 99).
- 6 Pulse **START/COPY/SET**.

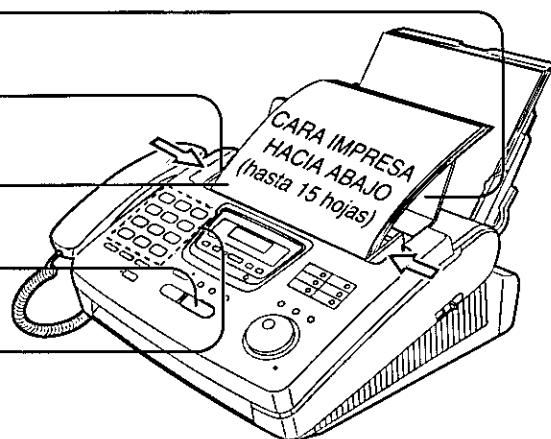

Operación del sistema de contestación

■ Preparación del mensaje de voz y de la recepción de documentos

- 1 Pulse **AUTO ANSWER** hasta que se encienda la luz AUTO ANSWER.

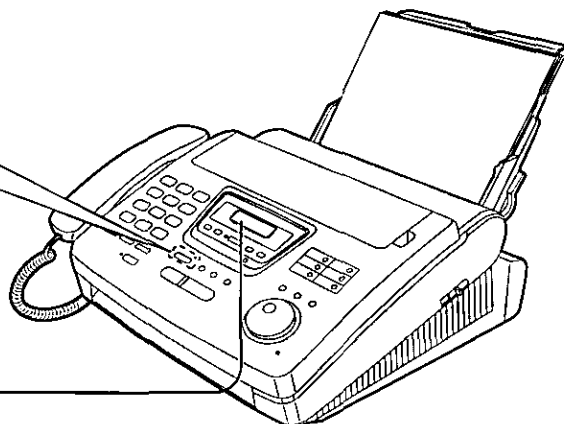
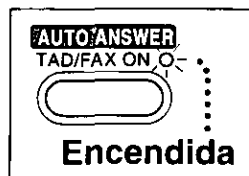

- 2 Asegúrese de que el visualizador muestre "TAD/FAX MODE".

■ Escucha de mensajes grabados

- 1 Pulse **PLAY MESSAGES** cuando la luz PLAY MESSAGES esté parpadeando o encendida.

- Cuando la luz PLAY MESSAGES esté:
 - parpadeando, la unidad sólo reproducirá los mensajes nuevos.
 - encendida, la unidad reproducirá todos los mensajes.

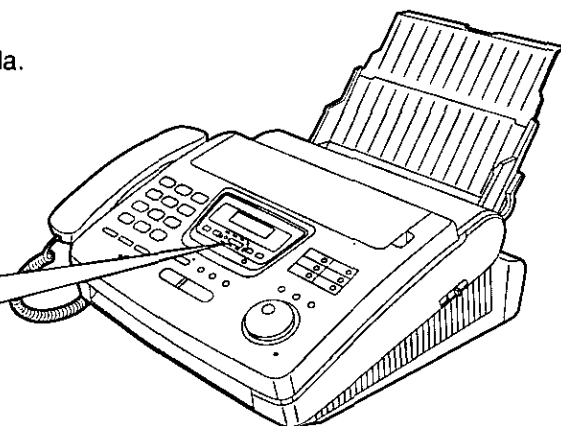
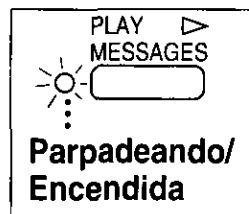

■ Borrado de mensajes grabados

Borrado de un mensaje específico

- 1 Pulse **ERASE** mientras escucha el mensaje que desee borrar.

Borrado de todos los mensajes

- 1 Pulse **ERASE** después de escuchar todos los mensajes.
- 2 Pulse **START/COPY/SET**.
- 3 Pulse de nuevo **START/COPY/SET**.

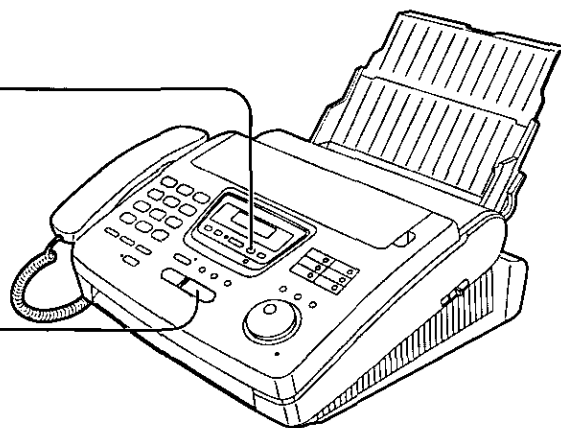

Index

Index

- A** Accessories 17, 18
- Advanced features 141, 142
 - (Resetting) 123
- Alert (Memory reception) 84
 - (Message) 106
 - (Recording time) 107
- Area code 51
- AUTO ANSWER button 70, 71, 89
- AUTO ANSWER setting 70, 71, 73, 80
- Automatic dialing mode setting 28

- B** Basic features 140
- BROADCAST key 66, 67
- Broadcast report 67

- C** Call counter 94
- Caller ID 45
- Caller ID list 52, 121
- CALLER ID SEARCH button 46–49
- Caller's recording time 106
- Character table 31, 39
- Cleaning 120
- COLLATE button 87
- Communication messages 108
- Connecting tone 69
- Connections 6, 28
- Copy (Collated) 87, 88
 - (Enlargement/reduction) 87, 88
 - (Multiple copies) 87
- COPY button 11, 87

- D** Date and time 29
- Delayed transmission 64
- Dialing mode 37
- DIGITAL SP-PHONE button 34, 35, 53
- Directory feature 41, 44, 56
- DIRECTORY
 - PROGRAM button 38, 41–43, 66
- Display contrast 123
- Distinctive Ring service 76, 77
- Document feeder cleaning 120
- Document jam 117
- Document size 60, 128

- E** Enlarge/Reduce copy 87, 88
- ERASE button 92, 94
- Error messages 108–110
- Extension telephone 79, 82

- F** Facsimile telephone number 32
- Fax activation code 82
- Fax auto redial 55
- FAX ONLY mode 70, 73, 74
- FAX ONLY ring count 74
- Fax pager 85
- Fax voice guidance 122
- Fax voice guide 61

- Feature list 121
- Feeder cleaning 120
- Feeder jam 117
- Feeder pressure 117
- Film detection 86
- Film/Film cartridge (Installing) 4, 23, 24
 - (Replacing) 118, 119
- FILM REMAINING button 118
- FLASH button 36
- Friendly reception 72, 84

- G** Greeting message (Message transfer) .. 103
 - (TAD/FAX) 90, 91
 - (TEL/FAX) 90, 91

- H** Handset cord 6, 28
- Handset receiver volume 33
- HELP button 19
- HYPHEN key 31, 38, 39

- I** ICM monitor 107
- Ink film 118, 119
- INSERT key 30, 31, 39
- IQ-FAX 57–59
- IQ-FAX button 59

- J** Jam 115–117
- JOG DIAL (Making a voice call) 44
 - (Repeating the recorded messages) .. 95
 - (Selecting characters) .. 31, 39
 - (Sending faxes) 56
 - (Skipping the recorded messages) .. 95
 - (Storing) 41–43
- Journal auto print 63
- Journal report 63, 121

- L** LCD contrast 123
- LCD display (Error messages) 109, 110
- Legal paper 25
- List (Caller ID) 52, 121
 - (Feature) 121
 - (Printer test) 121
 - (Telephone number) 121
- Location panel 20, 21
- Logo 30, 31
- LOWER key 38, 40, 55

- M** Memory reception alert 72, 84
- Memory transmission 65
- Message alert 106
- Message transfer 102–104
- MUTE button 34

- N** NAME/TEL NO. key 44

- O**
 - One-Touch Dial (Making a voice call) . . . 40
 - (Sending faxes) 55
 - (Storing) 38, 39
 - Other size documents 83
 - Overseas transmission mode 68
 - Overview 22

- P**
 - Pager call 85
 - Paper jam 115, 116
 - Paper stacker 5, 25
 - Paper tray 5, 26
 - PAUSE button 36
 - PLAY MESSAGES button 94
 - Power down report 114
 - Power failure 114
 - Power supply/cord 6, 28, 128
 - Printing paper size 128
 - Printing reports 121
 - Problem solving 111–113
 - Programmable features 140–142
 - Pulse 37

- Q**
 - QUICK button 95

- R**
 - Receiving (Fax) 10, 72
 - (Setting) 70, 71
 - Receiving reduction 83
 - RECORD button 91, 96
 - Recording (Greeting message) 91
 - (Memo message) 96
 - (Telephone conversation) 96
 - Recording paper 5, 26, 27, 128
 - Recording paper jam 115, 116
 - Recording time alert 107
 - Recording time for TAD/FAX greeting message 93
 - REDIAL button 34, 54
 - Remote operation ID 98
 - Report (Broadcast) 67
 - (Caller ID) 52, 121
 - (Feature setting) 121
 - (Journal) 63, 121
 - (Printer test list) 121
 - (Sending) 62
 - (Telephone numbers) 121
 - Reset 123
 - RESOLUTION button 54–56, 59, 87
 - Ring count (FAX ONLY) 74
 - (TAD/FAX) 105
 - (TEL/FAX) 81
 - Ring pattern detection 76, 77
 - Ringer volume 33

- S**
 - SECRET key 38, 39, 41
 - Sending (From memory) 65
 - (IQ-FAX) 57–59
 - (JOG DIAL) 56
 - (Manually) 9, 54
 - (Multiple stations) 66, 67
 - (One-Touch Dial) 55
 - Sending document (Does not feed or multi-feeds) 117
 - Sending jam 117
 - Sending report 62
 - Set default 123
 - Silent fax recognition ring 81
 - SLOW button 95
 - Speaker volume 33
 - Specifications 128
 - Storing (Caller ID list) 52, 121
 - (JOG DIAL) 41–43
 - (One-Touch Dial) 38, 39

- T**
 - TAD/FAX mode 89
 - TAD/FAX ring count 105
 - TEL mode 71, 72
 - TEL/FAX delayed ring count 81
 - TEL/FAX mode 78–81
 - Telephone line cord 6, 28
 - Telephone number list 121
 - Thermal head cleaning 120
 - Toll saver 105
 - TONE button 36
 - Transmission (IQ-FAX) 57–59
 - (JOG DIAL) 56
 - (Manually) 9, 54
 - (One-Touch Dial) 55
 - Transmittable document 60, 128

- V**
 - Voice call (Answering) 8, 35
 - (JOG DIAL) 44
 - (Making) 7, 34
 - (One-Touch Dial) 40
 - Voice contact 53
 - Voice time/day stamp 94
 - VOLUME button 33

- Z**
 - ZOOM button 87, 88

Features Summary

Summary of user programmable features =====

Basic features

Code	Feature & Display	Available settings	Meaning	Page
#01	Setting the date and time <input type="text" value="SET DATE & TIME"/>	(2 digits for each entry)	mm/dd/yy hh:mm	29
#02	Setting your logo <input type="text" value="YOUR LOGO"/>	(Up to 30 characters)		30
#03	Setting your facsimile telephone number <input type="text" value="YOUR FAX NO."/>	(Up to 20 digits)		32
#04	Printing the sending report <input type="text" value="SENDING REPORT"/>	ERROR ON OFF	If transmission fails Activate Deactivate	62
#06	Setting the ring count in the TAD/FAX mode <input type="text" value="TAD RING COUNT"/>	1, 2, 3, 4 TOLL SAVER RINGER OFF	1 to 4 rings Saves you the charges for the call. Does not ring.	105
	Setting the ring count in the FAX ONLY mode <input type="text" value="FAX RING COUNT"/>	1, 2, 3, 4,	1 to 4 rings	74
#10	Setting the caller's recording time <input type="text" value="RECORDING TIME"/>	VOX 1 MIN	Unlimited 1 minute	106
#11	Setting the remote operation ID <input type="text" value="REMOTE TAD ID"/>	ID=111	Any 3-digit number except a number using digits 0 or 7.	98
#13	Setting the dialing mode <input type="text" value="DIALING MODE"/>	AUTO TONE PULSE	Sets the dialing mode automatically. Sets to TONE. Sets to PULSE.	37
#15	Setting the memory transmission <input type="text" value="SEND BY MEMORY"/>	ON OFF	Activate Deactivate	65

(The pre-selected value is in bold.)

Note:

- You can display the basic features in the order above by rotating instead of entering the code number (#01, #02, etc.).

Features Summary

Advanced features

Code	Feature & Display	Available settings	Meaning	Page
#22	Setting the journal report to print automatically AUTO JOURNAL	ON	Activate	63
		OFF	Deactivate	
#23	Sending documents overseas OVERSEAS MODE	ON	Activate	68
		OFF	Deactivate	
#25	Sending a fax at a specified time DELAYED SEND	ON	Activate	64
		OFF	Deactivate	
#26	Setting the Caller ID list to print automatically AUTO CALL. LIST	ON	Activate	52
		OFF	Deactivate	
#30	Setting the silent fax recognition ring count SILENT FAX RING	3, 4, 5, 6	3 to 6 rings	81
#31	Setting the Distinctive Ring pattern RING DETECTION	A, B, C, D	Patterns A-D	77
		OFF	Deactivate	
#36	Receiving other sizes of documents RCV REDUCTION	100%	Deactivate reduction	83
		92%	92% reduction	
		86%	86% reduction	
		72%	72% reduction	
#39	Changing the LCD display contrast LCD CONTRAST	NORMAL	Normal contrast	123
		DARKER	Darker contrast	
#41	Changing the fax activation code FAX ACTIVATION	ON / CODE= * 9	Activate	82
		OFF	Deactivate	
#42	Setting the message alert MESSAGE ALERT	ON	Activate	106
		OFF	Deactivate	
#43	Setting the recording time alert REC. TIME ALERT	ON	Activate	107
		OFF	Deactivate	
#44	Setting the memory reception alert RECEIVE ALERT	ON	Activate	84
		OFF	Deactivate	
#46	Setting the friendly reception FRIENDLY RCV	ON	Activate	84
		OFF	Deactivate	
#47	Setting the fax voice guidance FAX GUIDANCE	ERROR	If transmission/reception error occurs.	122
		ON	Activate	
		OFF	Deactivate	

(The pre-selected value is in bold.)

(continued)

Features Summary

Advanced features

Code	Feature & Display	Available settings	Meaning	Page
#54	Setting the recording time for the TAD/FAX greeting message <input type="text" value="GREETING TIME"/>	16s	16 seconds long	93
		60s	60 seconds long	
#60	Setting the message transfer/pager call <input type="text" value="MESSAGE TRANS."/>	MESSAGE	Transfers incoming messages.	104
		PAGER	Calls your pager.	
		OFF	Deactivate	
#61	Recording the message transfer greeting message <input type="text" value="TRNS-GREETING"/>	CHECK	Checks the greeting message.	103
		RECORD	Records the greeting message.	
		ERASE	Erases the greeting message.	
#67	Setting the ICM monitor <input type="text" value="ICM MONITOR"/>	ON	Activate	107
		OFF	Deactivate	
#70	Signaling your pager when your unit receives a fax <input type="text" value="FAX PAGER CALL"/>	ON	Activate	85
		OFF	Deactivate	
#75	Setting the IQ-FAX function <input type="text" value="IQ-FAX"/>	ON	Activate	58
		OFF	Deactivate	
#76	Setting the connecting tone <input type="text" value="CONNECTING TONE"/>	ON	Activate	69
		OFF	Deactivate	
#77	Changing the AUTO ANSWER setting <input type="text" value="AUTO ANSWER"/>	TAD/FAX	Telephone Answering Device / Facsimile mode	73
		FAX ONLY	Facsimile only mode	
		TEL/FAX	Telephone/Facsimile mode	
#78	Setting the TEL/FAX delayed ring count <input type="text" value="TEL/FAX RING"/>	1, 2, 3, 4	1 to 4 rings	81
#79	Setting the film detection <input type="text" value="FILM DETECTION"/>	ON	Activate	86
		OFF	Deactivate	
#80	Resetting the advanced features <input type="text" value="SET DEFAULT"/>	YES	Reset	123
		NO	Will not reset.	

(The pre-selected value is in bold.)

Panasonic FAX ADVANTAGE PROGRAM

*Free peace of mind,
direct from Panasonic*

NO EXTRA COST



- 1-year limited warranty¹ parts & labor**
- Toll-free help line**
- Free overnight replacement² and repair program**

The Panasonic Fax Advantage Consumer Service Program.

Panasonic knows that if your fax machine is not up and running, neither is your business. That's why we created the Panasonic Fax Advantage Program. Included at no extra cost with the purchase of a Panasonic Fax Machine, the Fax Advantage Program can provide a free replacement unit³ overnight if your original unit is in need of repair.

Here's how it works:

1. If you have a problem with your fax while it is covered by the one-year limited warranty¹, call our toll-free help-line at 1-800-HELPFAX.
2. Talk to one of our technical experts to diagnose your problem over the phone.
3. If repairs are necessary and you are entitled to service under the terms and conditions of the limited warranty¹, we will send a refurbished replacement unit to you overnight or second business day delivery, depending on the time of your call.

A second option available under our one-year limited warranty is to mail-in or carry-in your fax to one of our Regional Service centers, where the unit will be repaired and returned to you.

Instructions

If you choose to receive a replacement unit under the Fax Advantage Program, Panasonic will provide a replacement unit which will be completely refurbished, quality-tested by Panasonic technicians and individually hand-inspected before it is shipped to you. You will keep the replacement unit and send the original unit to us in the replacement unit's box. UPS will pick up the unit at no charge to you, should it be determined that you are entitled to warranty service. A proof-of-purchase must be included with the returned product. Any unit that is replaced by Panasonic and not shipped with proper proof-of-purchase by you will be subject to a minimum \$100.00 charge. The original unit must be properly packaged in the same manner as the replacement unit, utilizing

the packing materials provided. Damage due to improper or inadequate packing will be charged to you as an out-of-warranty cost.

If our 1-800-HELPFAX technicians determine that your unit may be an "out-of-box failure", we will attempt to provide you with a factory-new replacement unit³. You must ship a copy of your receipt with your original unit to verify that you purchased the unit within 10 days prior to your 1-800-HELPFAX call.

Requirements

You must give our technicians a valid credit card number (Discover, VISA, Master Card, or American Express/Optima). Product that is not returned to Panasonic by 10 business days after shipment of the replacement product will be charged to your credit card account at Panasonic's Suggested Retail Price (see dealer for details). If your original unit is not eligible for warranty service, your card will be charged for the non-warranty repair of the unit at Panasonic's current rate for parts and labor and for any shipping charges associated with this program. If you do not wish to pay out-of-warranty repair costs, you will be responsible for returning the replacement unit to Panasonic and for paying all shipping charges associated with this program including the overnight delivery of the replacement product to you, shipment of the problem unit to Panasonic, shipment of the replacement unit back to Panasonic and the return of your original unit back to you. Credit status will be verified prior to sending the replacement product.

1. See dealer for limited warranty details.
2. Replacement unit is refurbished.
3. Replacement program excludes Puerto Rico and is subject to termination at any time without advance notice.
4. "Out-of-box failure" is an inoperable unit that was purchased no more than 10 days prior to your 1-800-HELPFAX call, and would otherwise qualify for warranty service under the terms and conditions of the limited warranty.
5. Panasonic reserves the right to send a refurbished unit.

**Panasonic Consumer Electronics
Company, Division of Matsushita
Electric Corporation of America**
One Panasonic Way, Secaucus,
New Jersey 07094

**Panasonic Sales Company,
Division of Matsushita Electric
of Puerto Rico, Inc. ("PSC")**
Ave. 65 de Infantería, Km. 9.5
San Gabriel Industrial Park, Carolina,
Puerto Rico 00985